

Translations (A)

Instructions: Draw and label the translated image for each triangle.

1) Translation $(0,5)$

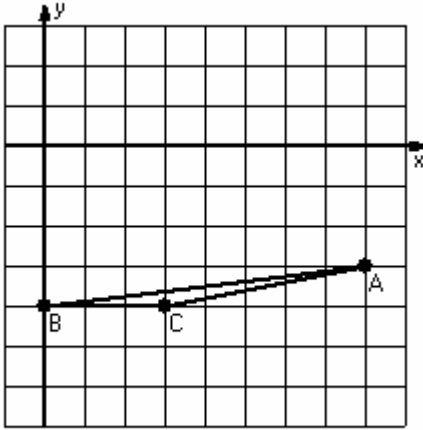

2) Translation $(-2,0)$

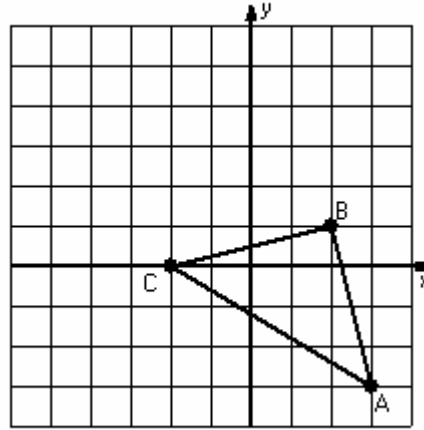

3) Translation $(3,1)$

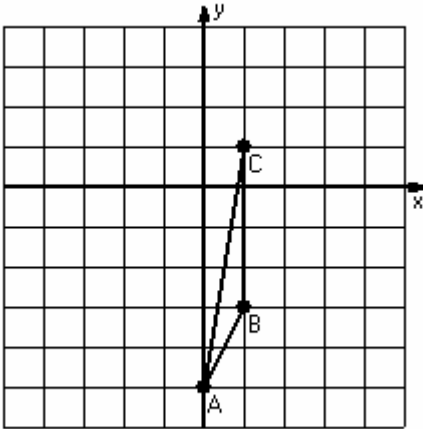

4) Translation $(-5,-4)$

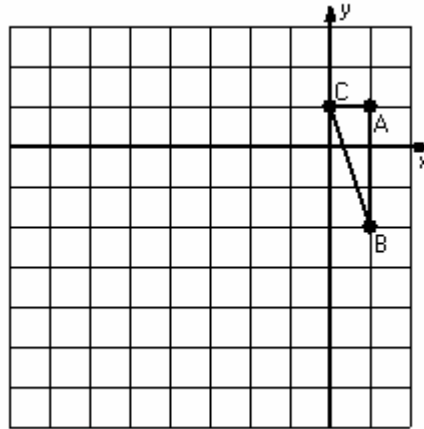

5) Translation $(0,-1)$

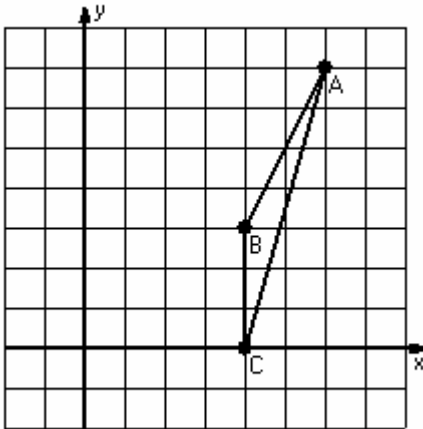

6) Translation $(4,5)$

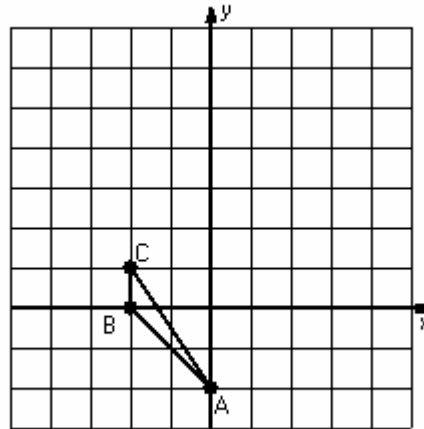

Translations Answer (A)

Instructions: Draw and label the translated image for each triangle.

1) Translation (0,5)

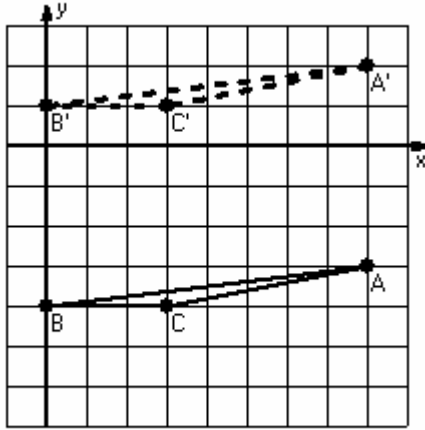

2) Translation (-2,0)

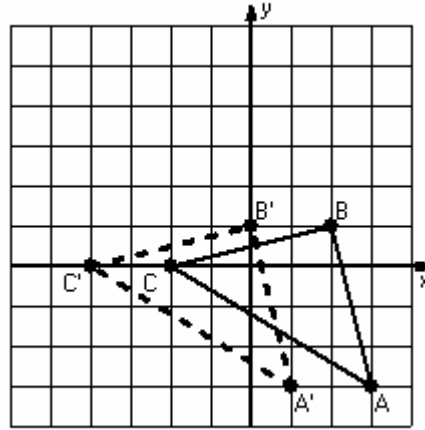

3) Translation (3,1)

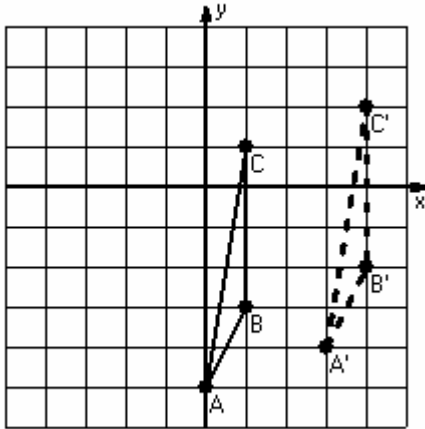

4) Translation (-5,-4)

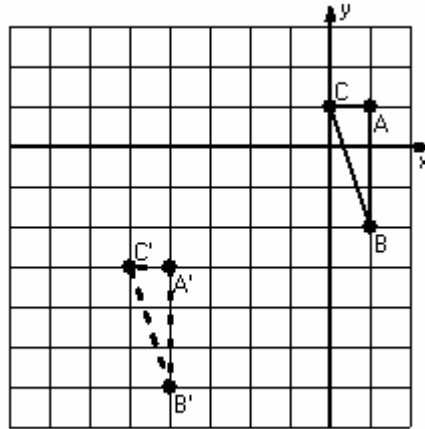

5) Translation (0,-1)

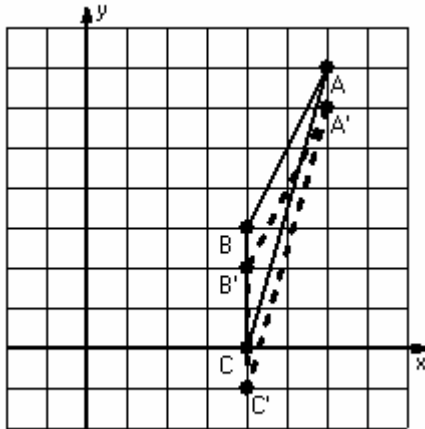

6) Translation (4,5)

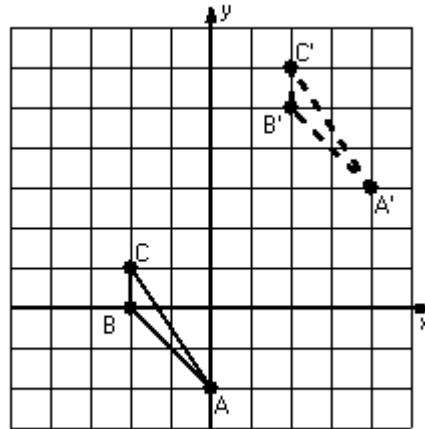

Translations (B)

Instructions: Draw and label the translated image for each triangle.

1) Translation $(0,-3)$

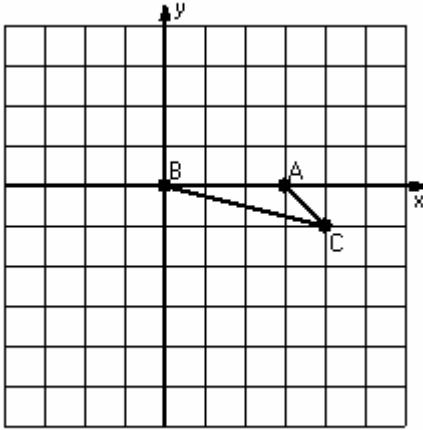

2) Translation $(-1,1)$

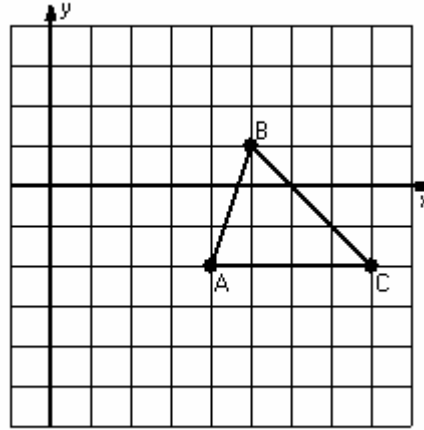

3) Translation $(-1,-3)$

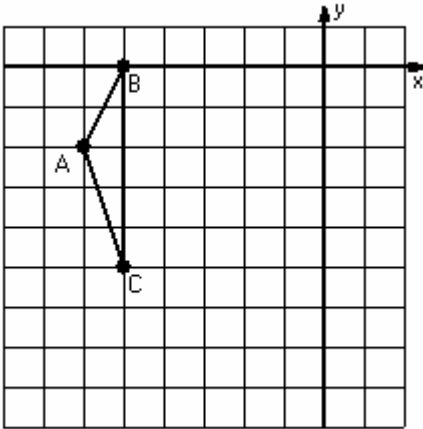

4) Translation $(2,3)$

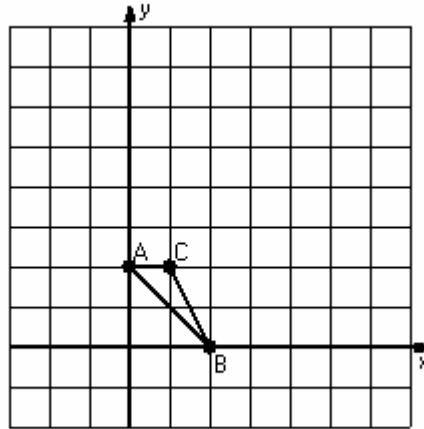

5) Translation $(0,4)$

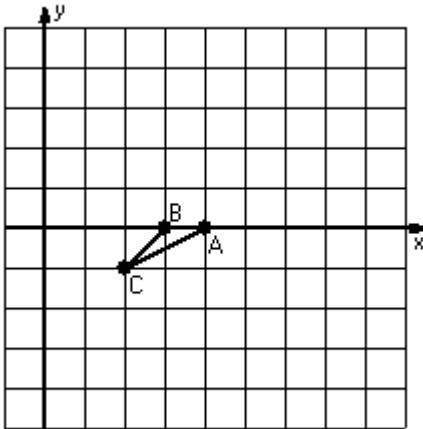

6) Translation $(1,-2)$

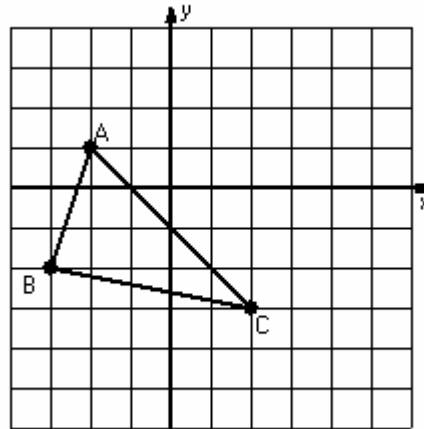

Translations Answer (B)

Instructions: Draw and label the translated image for each triangle.

1) Translation $(0, -3)$

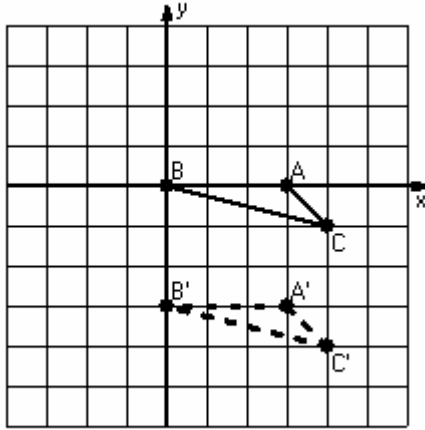

2) Translation $(-1, 1)$

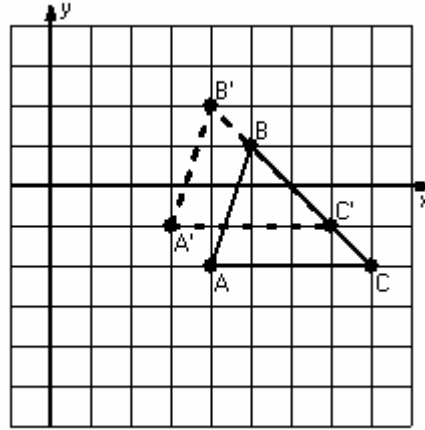

3) Translation $(-1, -3)$

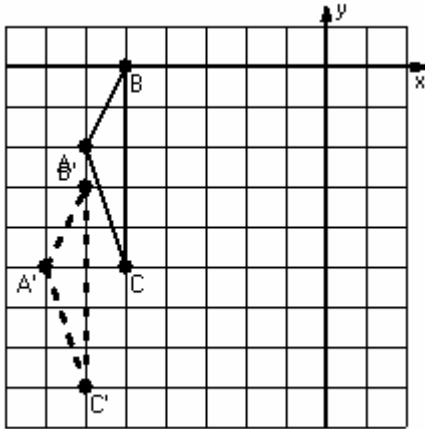

4) Translation $(2, 3)$

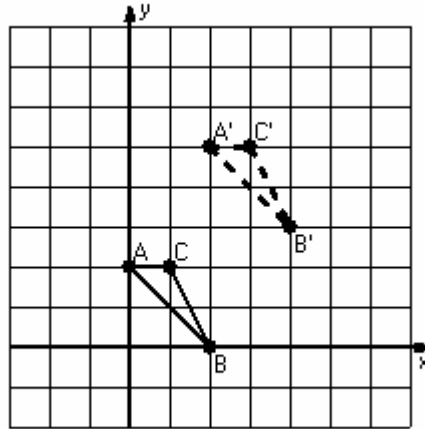

5) Translation $(0, 4)$

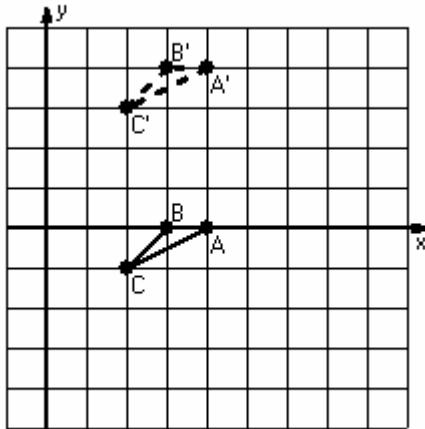

6) Translation $(1, -2)$

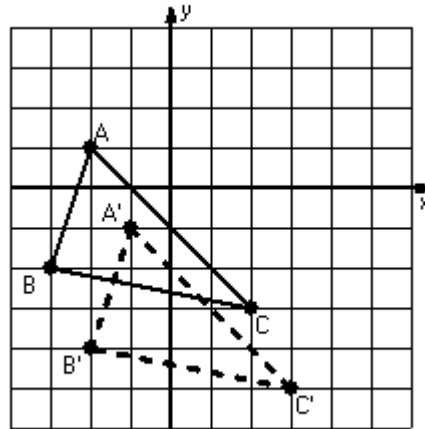

Translations (C)

Instructions: Draw and label the translated image for each triangle.

1) Translation $(1,-1)$

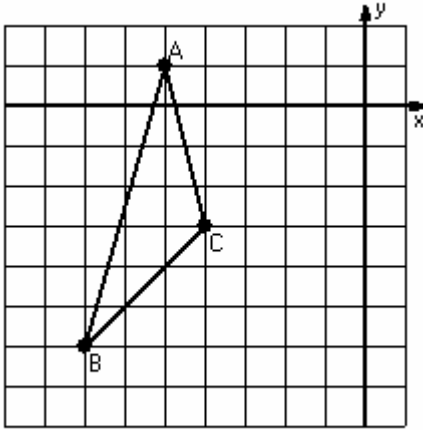

2) Translation $(1,4)$

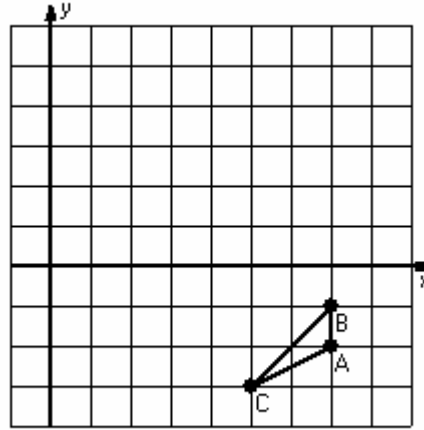

3) Translation $(-1,1)$

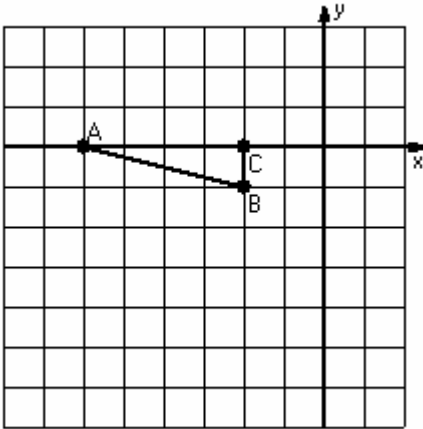

4) Translation $(1,4)$

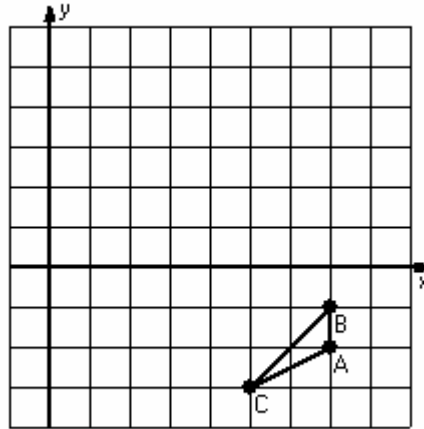

5) Translation $(0,1)$

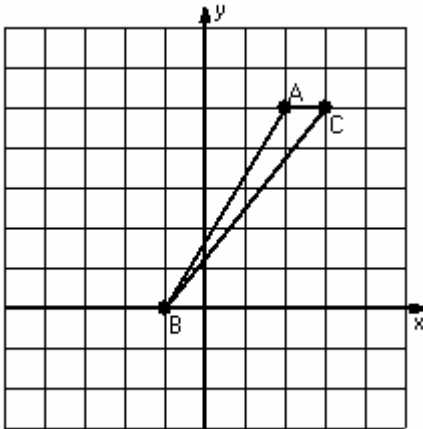

6) Translation $(-1,0)$

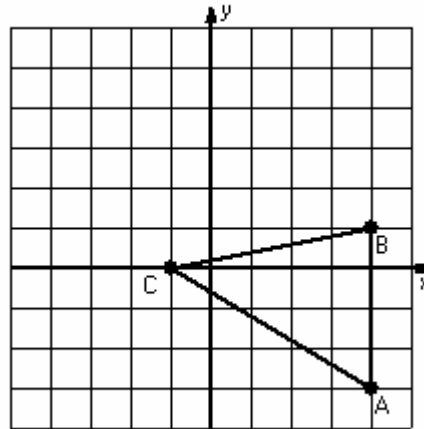

Translations Answer (C)

Instructions: Draw and label the translated image for each triangle.

1) Translation (1,-1)

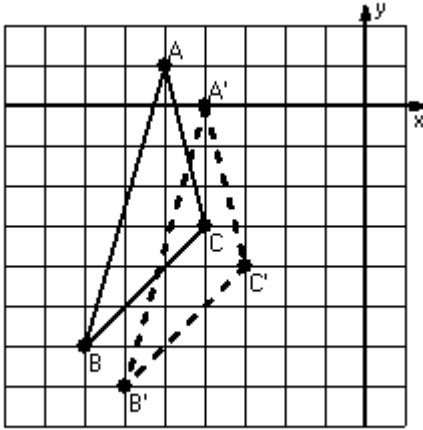

2) Translation (1,4)

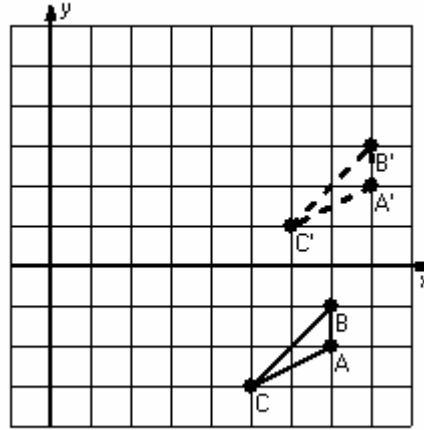

3) Translation (-1,1)

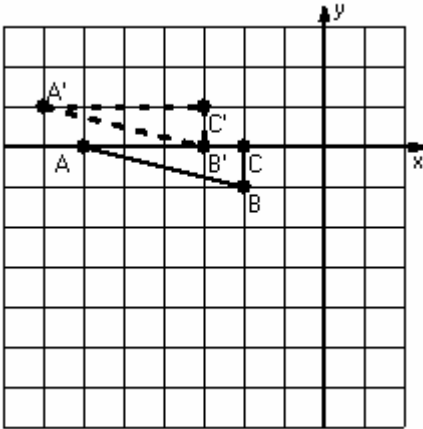

4) Translation (1,4)

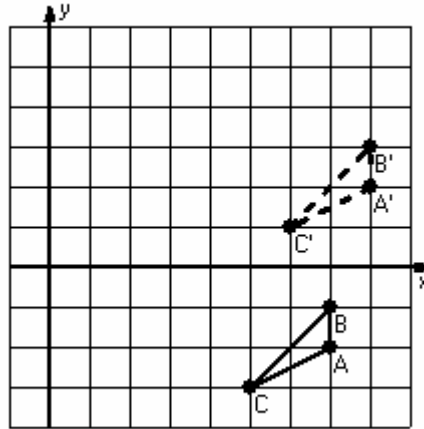

5) Translation (0,1)

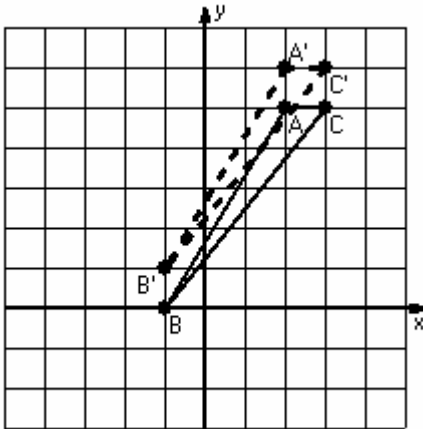

6) Translation (-1,0)

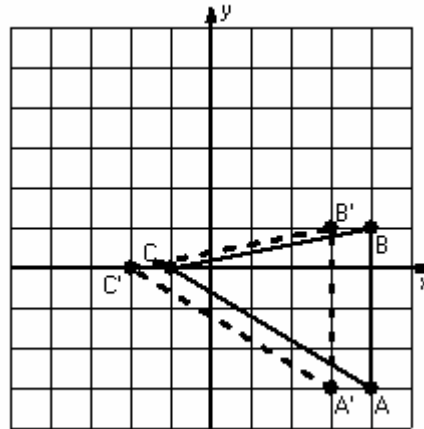

Translations (D)

Instructions: Draw and label the translated image for each triangle.

1) Translation $(3,4)$

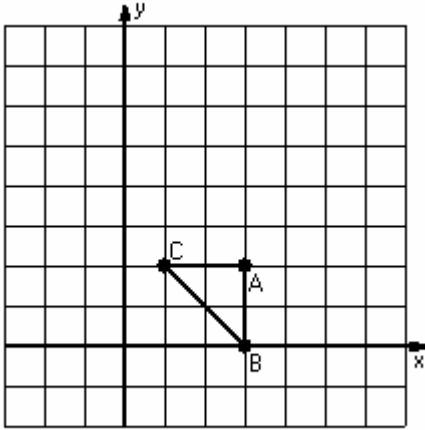

2) Translation $(-1,-1)$

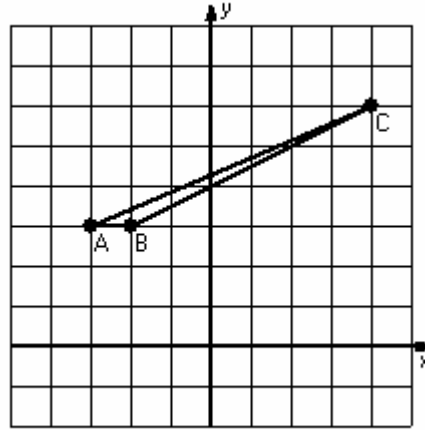

3) Translation $(-2,1)$

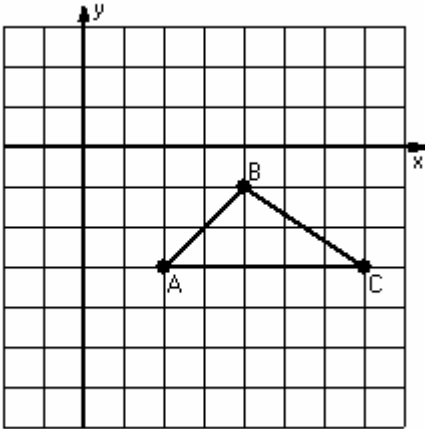

4) Translation $(1,4)$

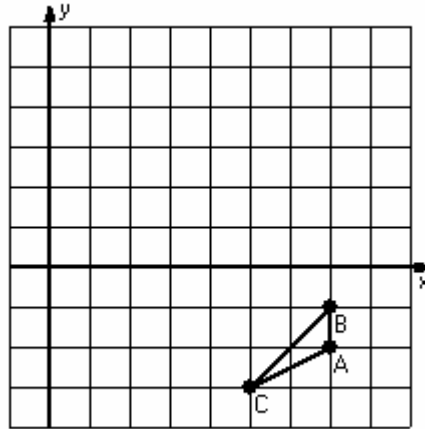

5) Translation $(4,3)$

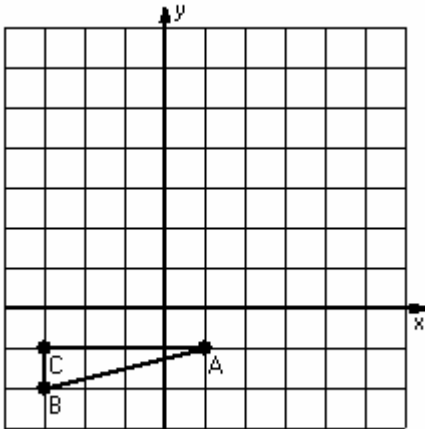

6) Translation $(-1,-1)$

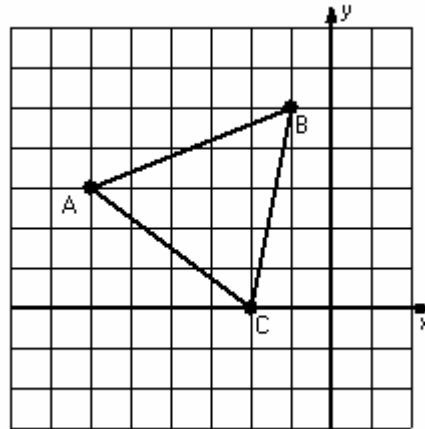

Translations Answer (D)

Instructions: Draw and label the translated image for each triangle.

1) Translation (3,4)

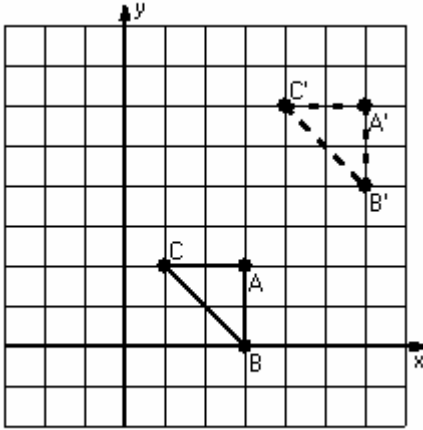

2) Translation (-1,-1)

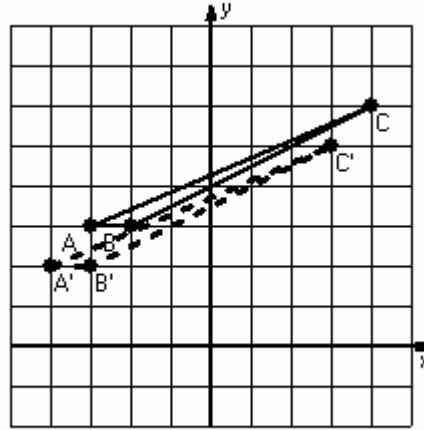

3) Translation (-2,-1)

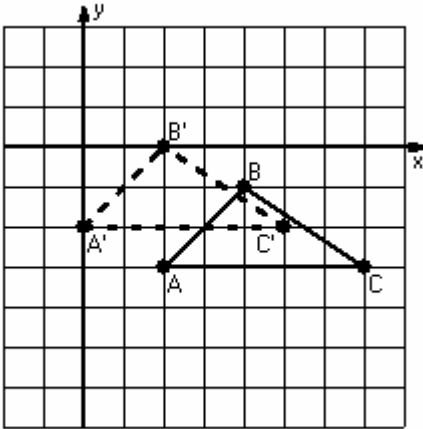

4) Translation (1,4)

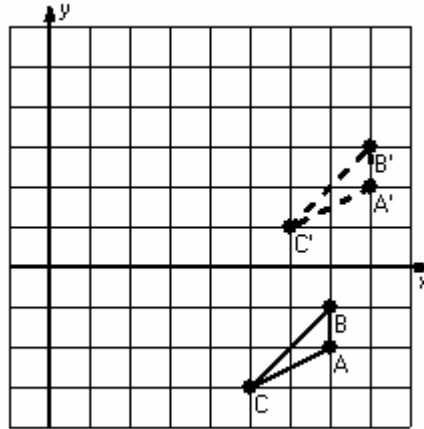

5) Translation (4,3)

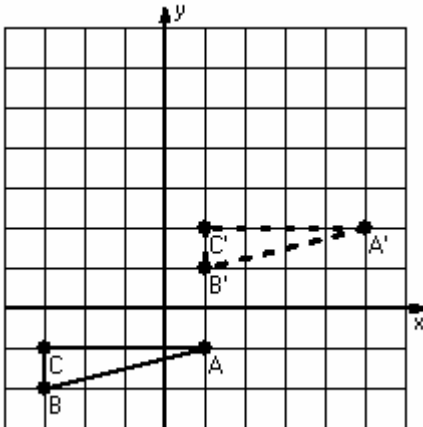

6) Translation (-1,-1)

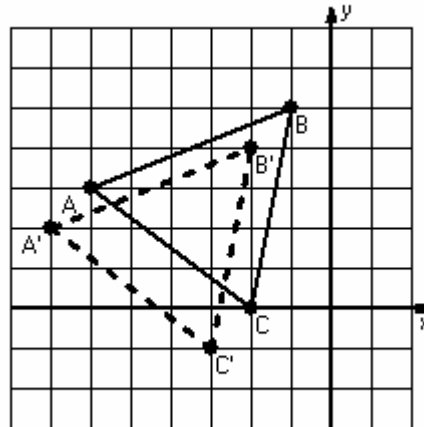

Translations (E)

Instructions: Draw and label the translated image for each triangle.

1) Translation $(3,2)$

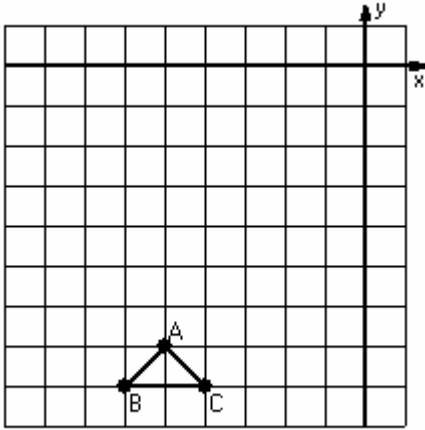

2) Translation $(4,-2)$

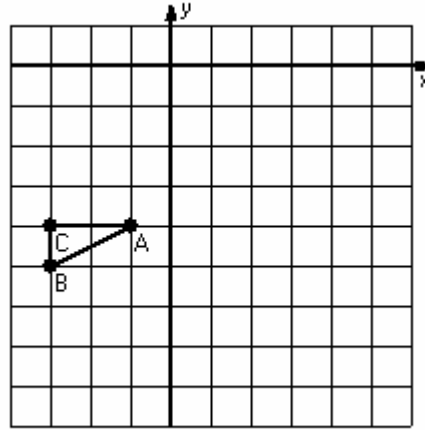

3) Translation $(-1,0)$

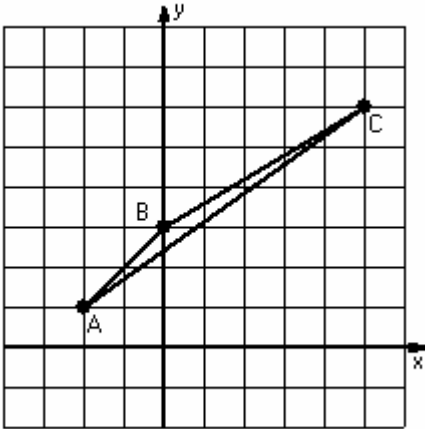

4) Translation $(2,0)$

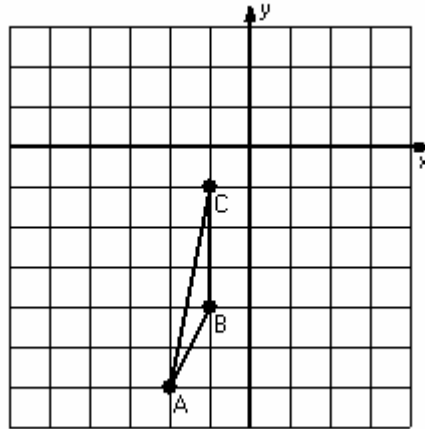

5) Translation $(-1,4)$

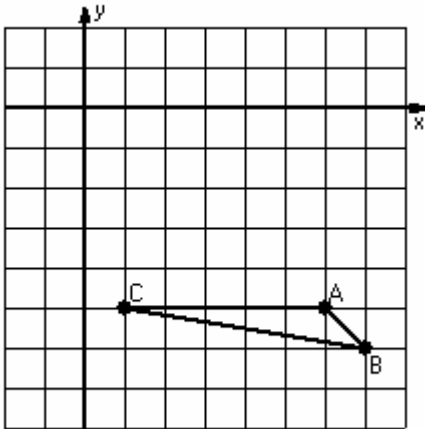

6) Translation $(-2,0)$

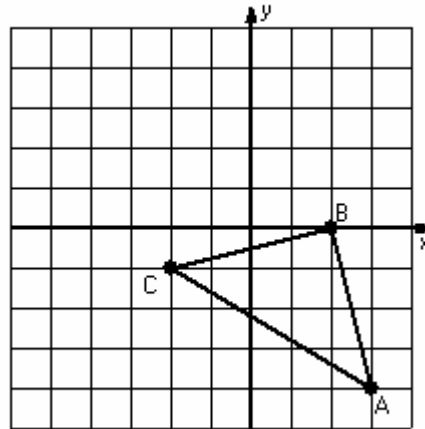

Translations Answer (E)

Instructions: Draw and label the translated image for each triangle.

1) Translation $(3,2)$

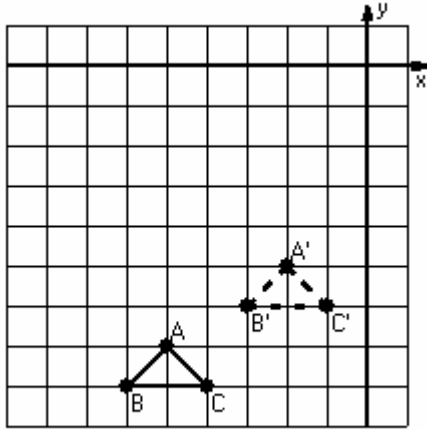

2) Translation $(4,-2)$

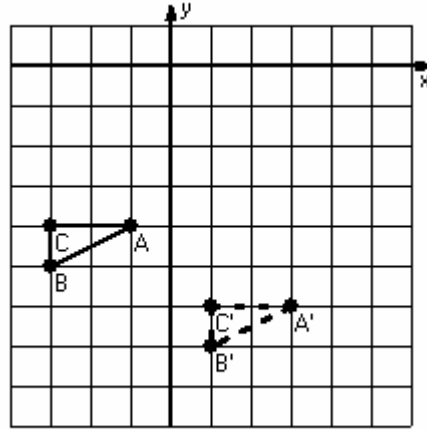

3) Translation $(-1,0)$

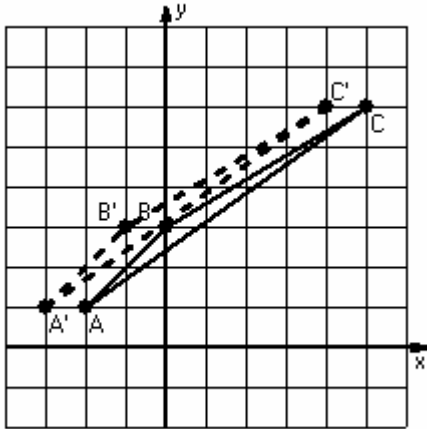

4) Translation $(2,0)$

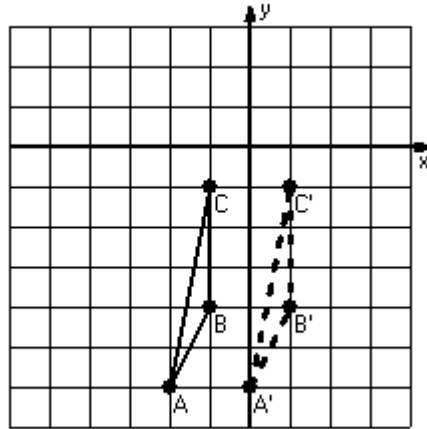

5) Translation $(-1,4)$

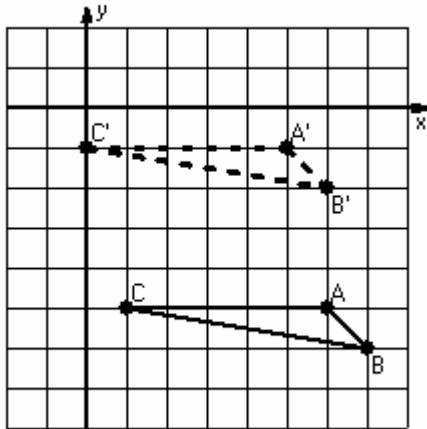

6) Translation $(-2,0)$

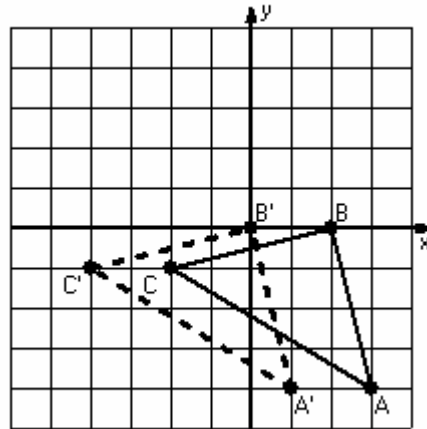

Translations (F)

Instructions: Draw and label the translated image for each triangle.

1) Translation $(1,4)$

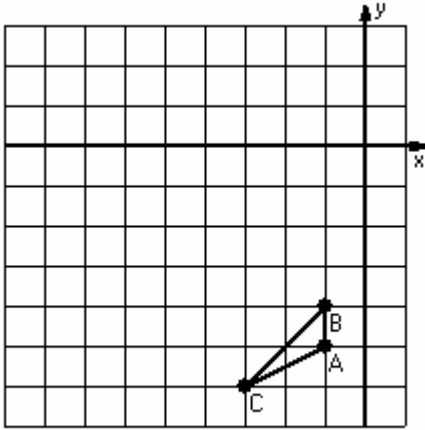

2) Translation $(1,-2)$

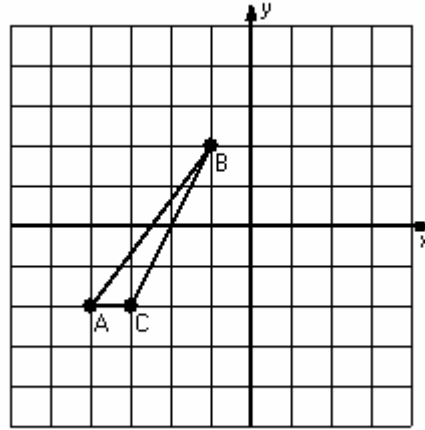

3) Translation $(-2,2)$

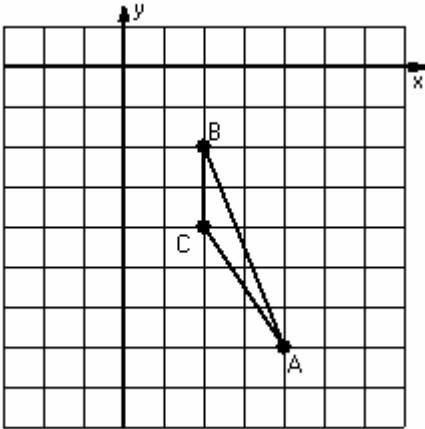

4) Translation $(-2,-1)$

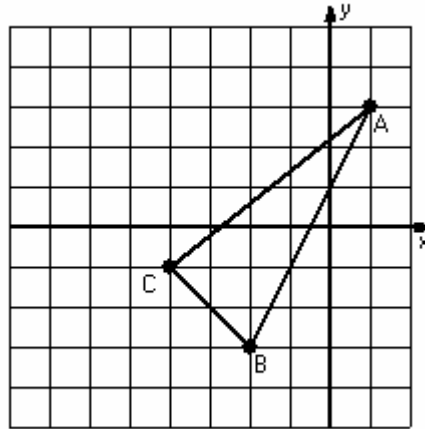

5) Translation $(-1,2)$

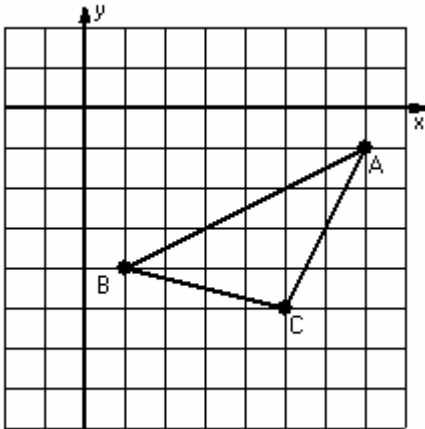

6) Translation $(3,2)$

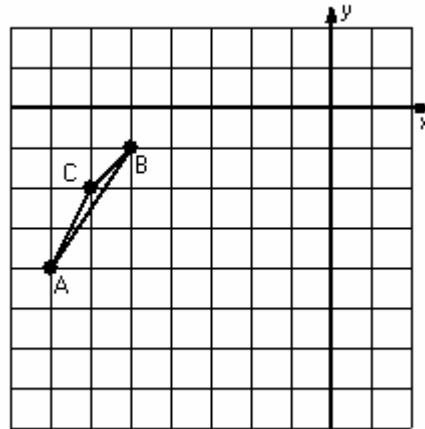

Translations Answer (F)

Instructions: Draw and label the translated image for each triangle.

1) Translation $(1,4)$

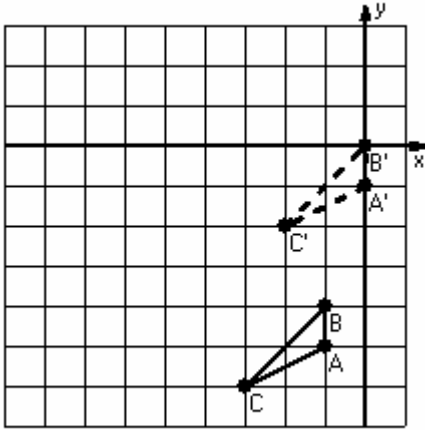

2) Translation $(1,-2)$

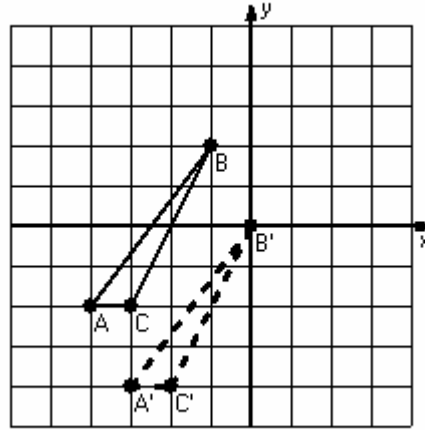

3) Translation $(-2,2)$

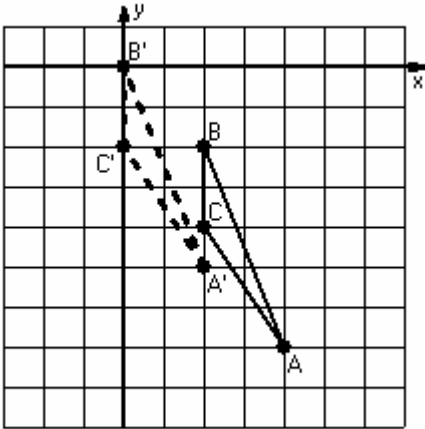

4) Translation $(-2,-1)$

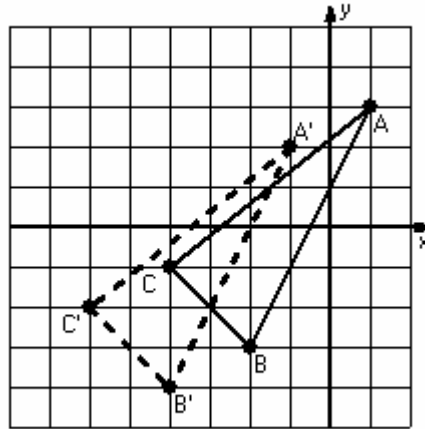

5) Translation $(-1,2)$

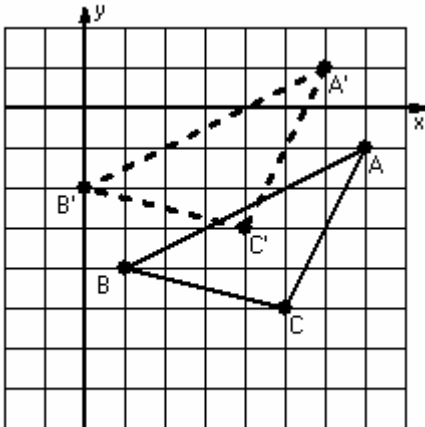

6) Translation $(3,2)$

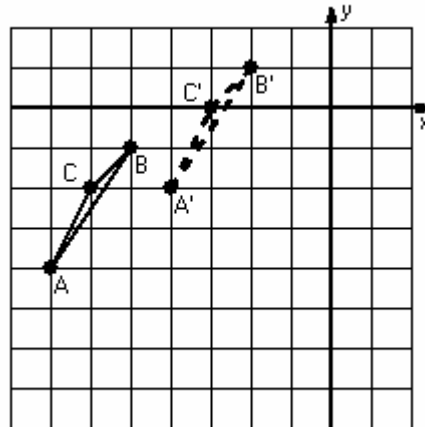

Translations (G)

Instructions: Draw and label the translated image for each triangle.

1) Translation (3,1)

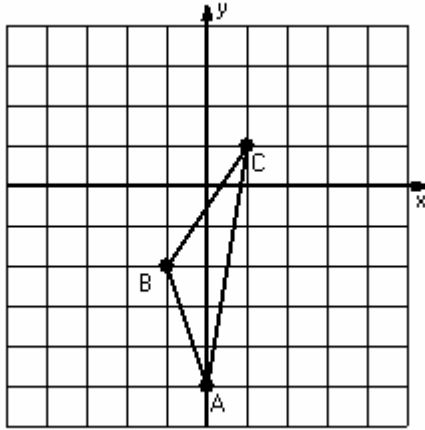

2) Translation (3,-4)

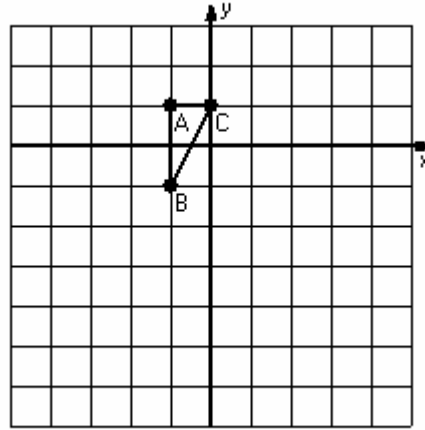

3) Translation (1,-1)

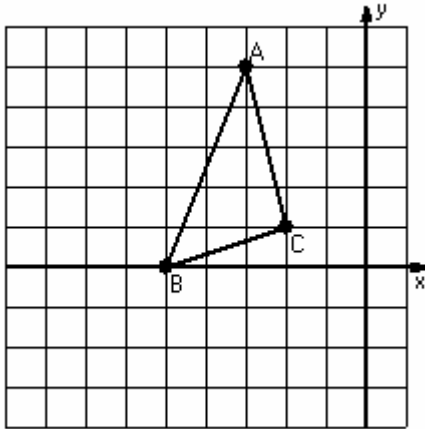

4) Translation (3,1)

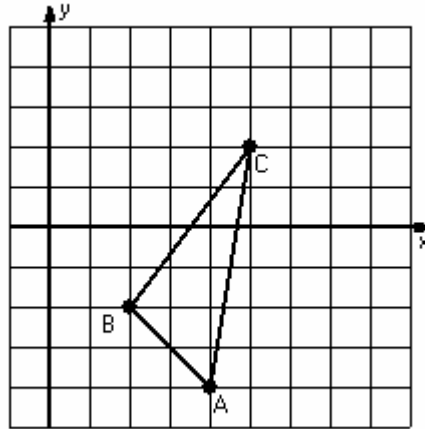

5) Translation (3,-4)

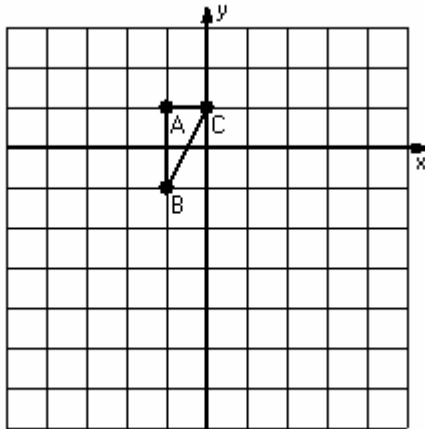

6) Translation (0,5)

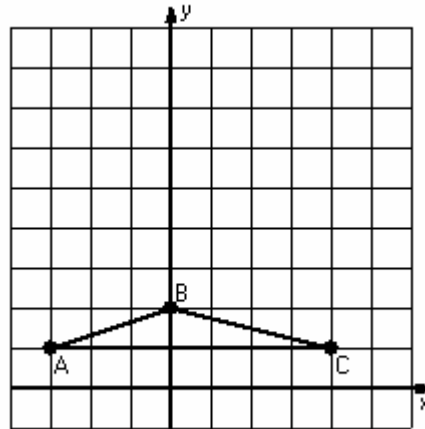

Translations Answer (G)

Instructions: Draw and label the translated image for each triangle.

1) Translation (3,1)

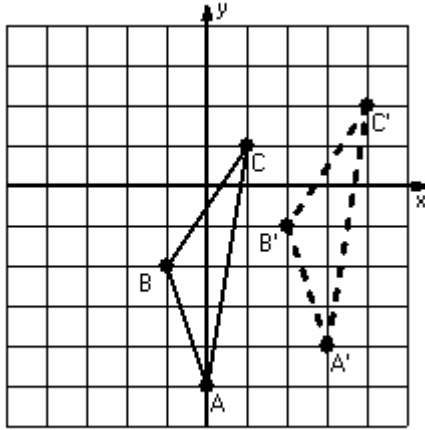

2) Translation (3,-4)

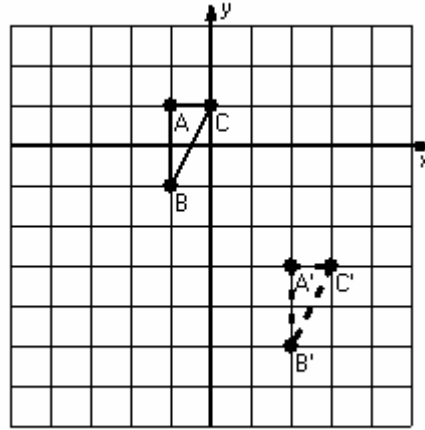

3) Translation (1,-1)

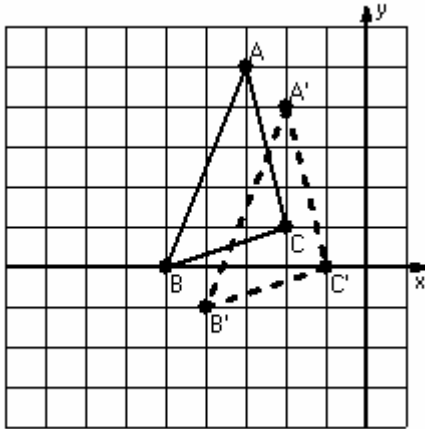

4) Translation (3,1)

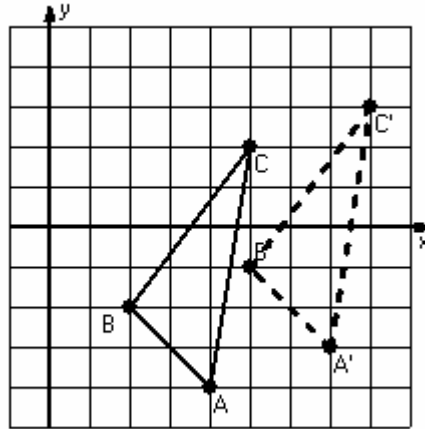

5) Translation (3,-4)

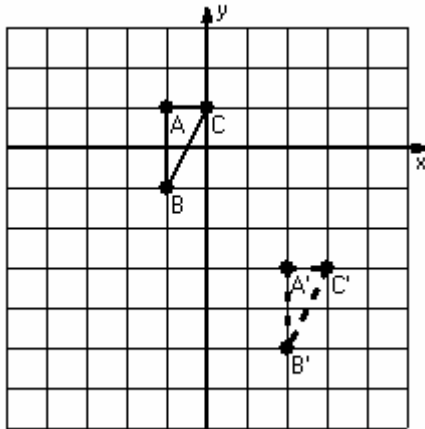

6) Translation (0,5)

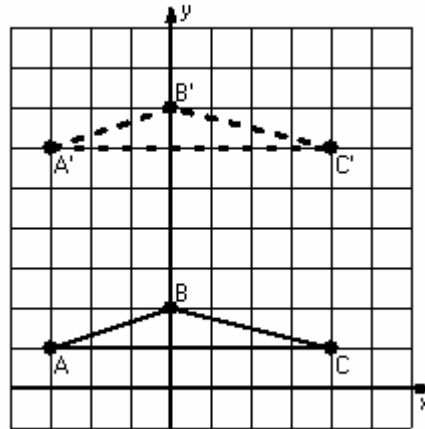

Translations (H)

Instructions: Draw and label the translated image for each triangle.

1) Translation $(2,3)$

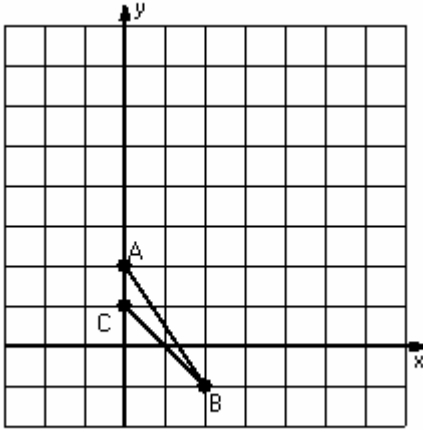

2) Translation $(-1,1)$

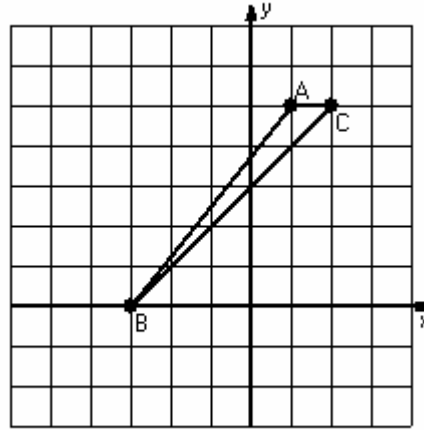

3) Translation $(-3,0)$

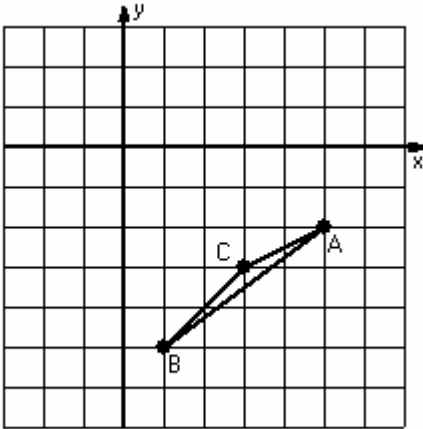

4) Translation $(2,3)$

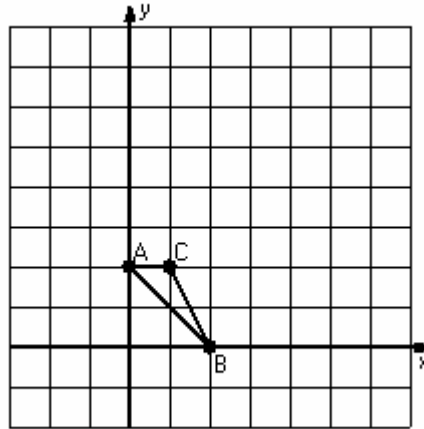

5) Translation $(1,-1)$

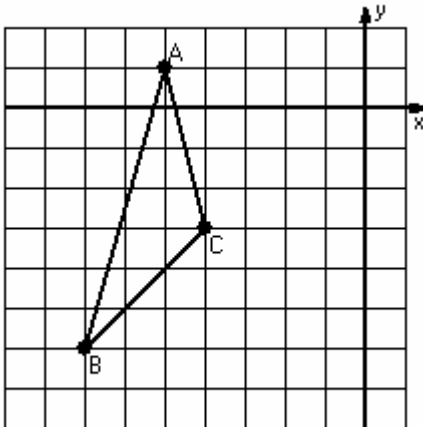

6) Translation $(2,0)$

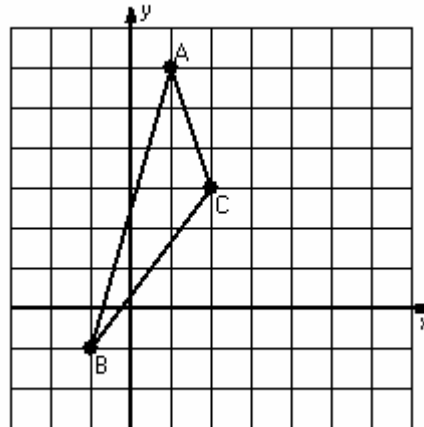

Translations Answer (H)

Instructions: Draw and label the translated image for each triangle.

1) Translation $(2,3)$

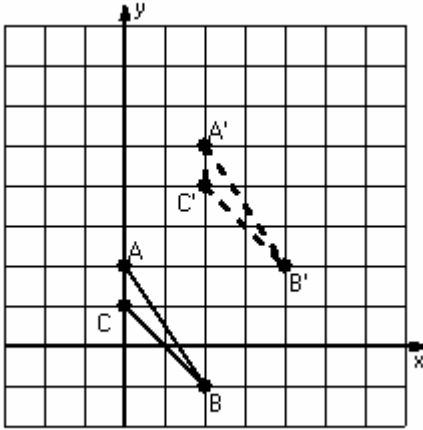

2) Translation $(-1,1)$

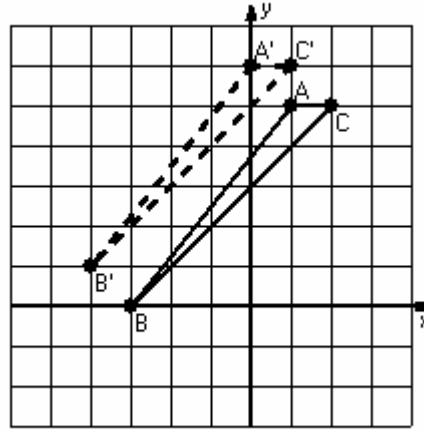

3) Translation $(-3,0)$

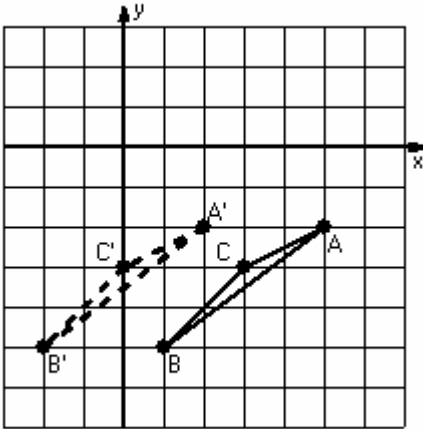

4) Translation $(2,3)$

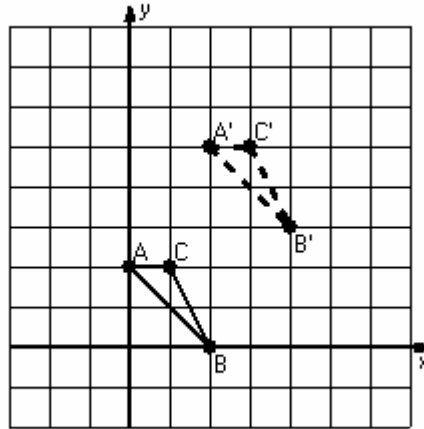

5) Translation $(1,-1)$

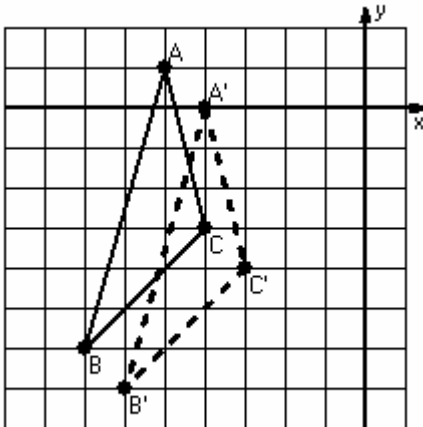

6) Translation $(2,0)$

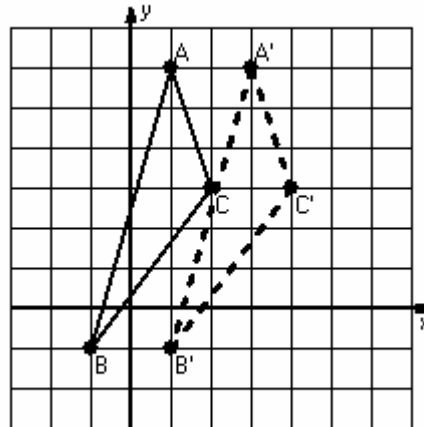

Translations (I)

Instructions: Draw and label the translated image for each triangle.

1) Translation $(0,5)$

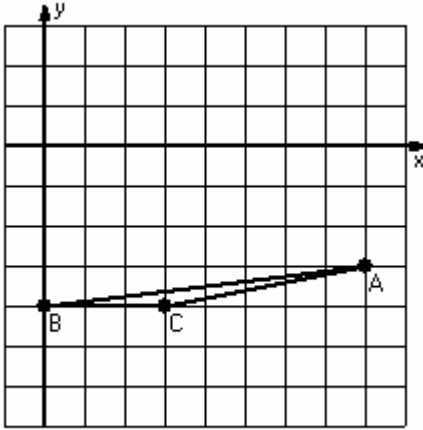

2) Translation $(1,-1)$

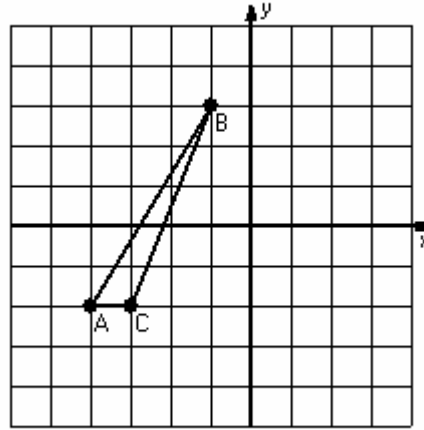

3) Translation $(-2,0)$

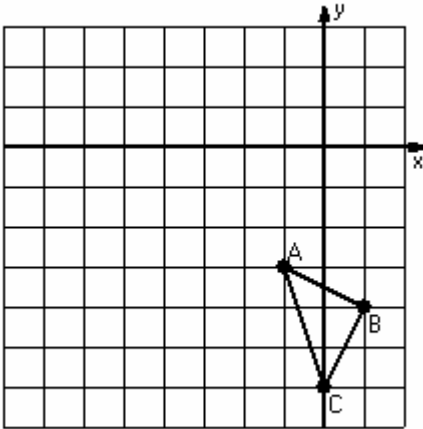

4) Translation $(3,-1)$

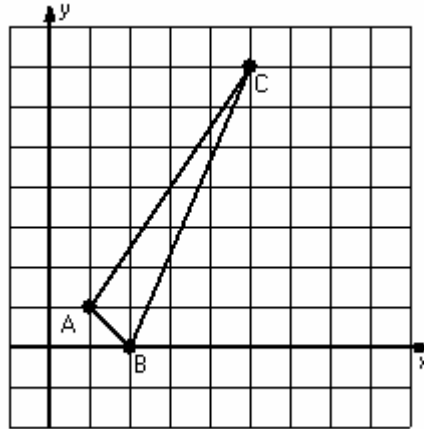

5) Translation $(1,4)$

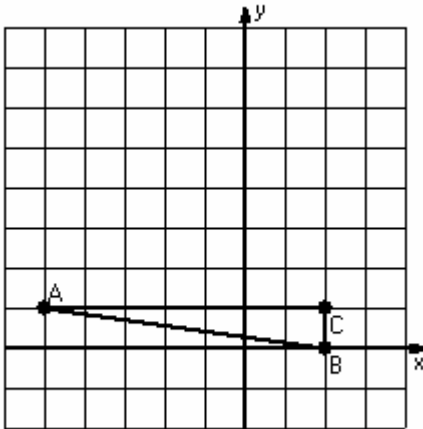

6) Translation $(-1,0)$

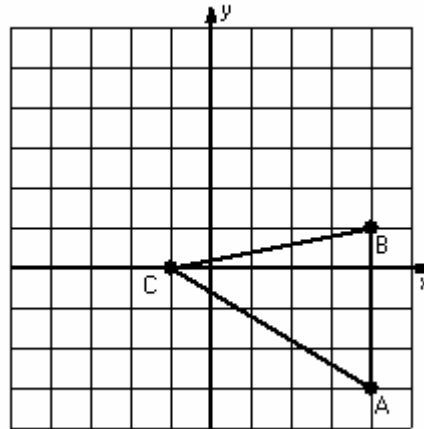

Translations Answer (I)

Instructions: Draw and label the translated image for each triangle.

1) Translation (0,5)

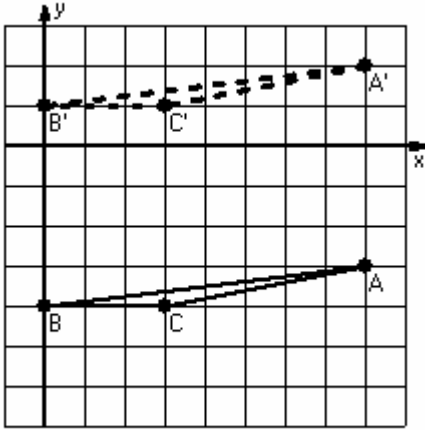

2) Translation (1,-1)

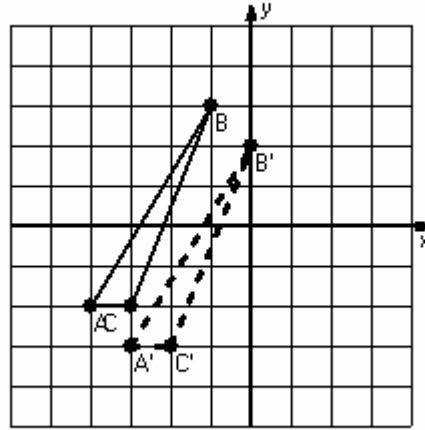

3) Translation (-2,0)

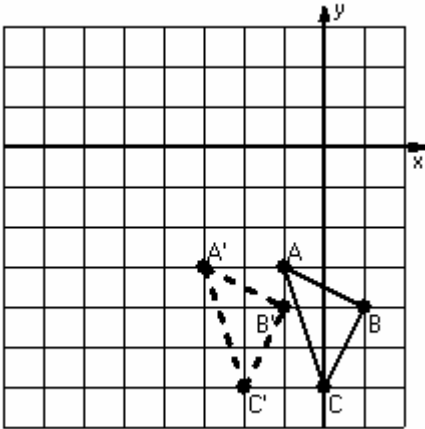

4) Translation (3,-1)

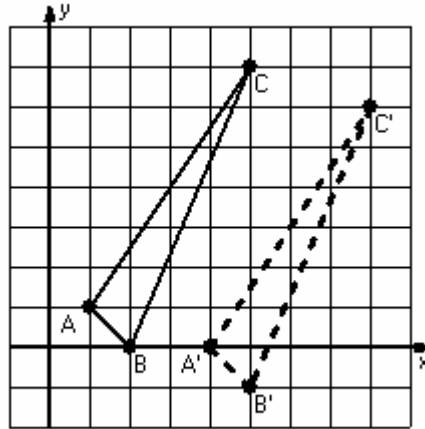

5) Translation (1,4)

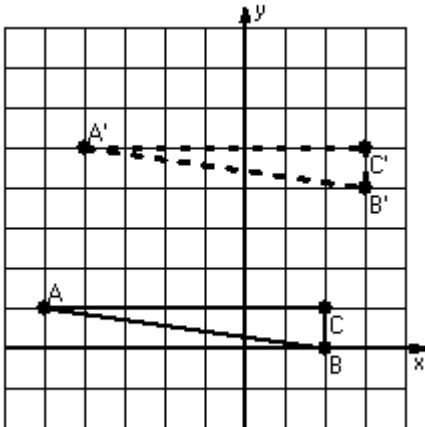

6) Translation (-1,0)

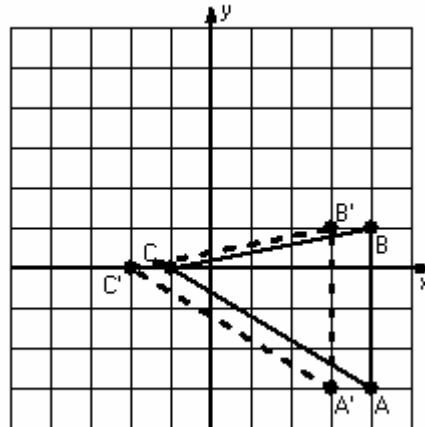

Translations (J)

Instructions: Draw and label the translated image for each triangle.

1) Translation $(-1, -3)$

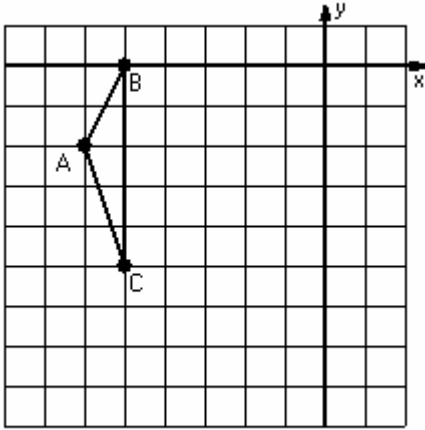

2) Translation $(3, -4)$

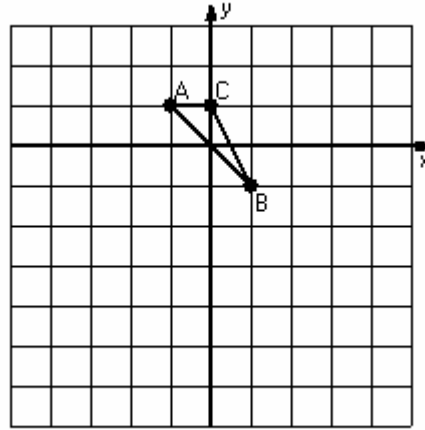

3) Translation $(4, 5)$

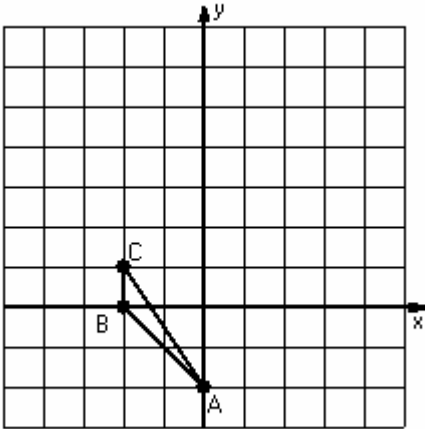

4) Translation $(-1, 2)$

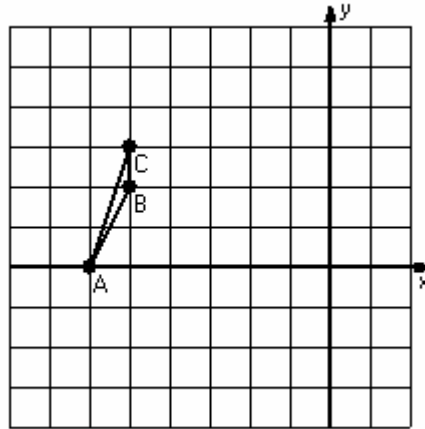

5) Translation $(-1, 2)$

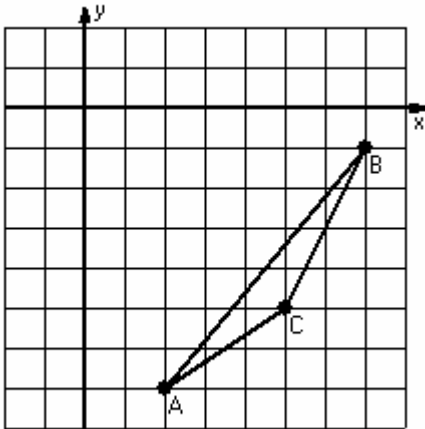

6) Translation $(-3, 1)$

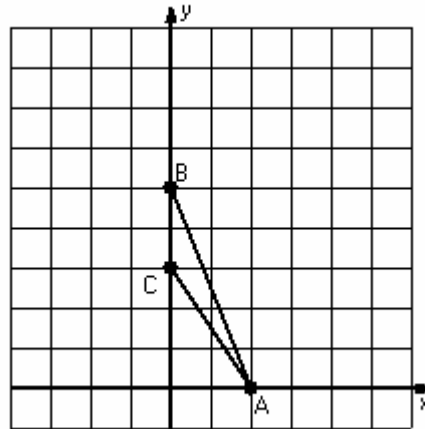

Translations Answer (J)

Instructions: Draw and label the translated image for each triangle.

1) Translation $(-1, -3)$

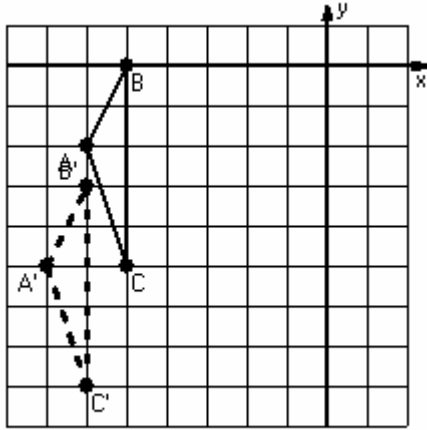

2) Translation $(3, -4)$

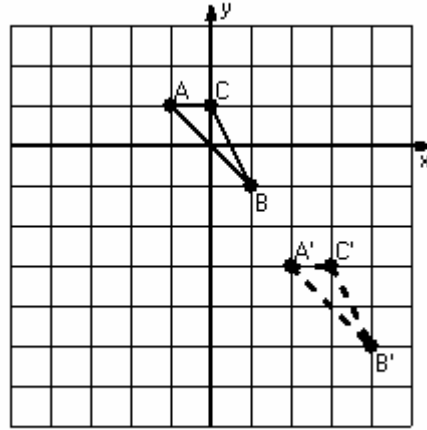

3) Translation $(4, 5)$

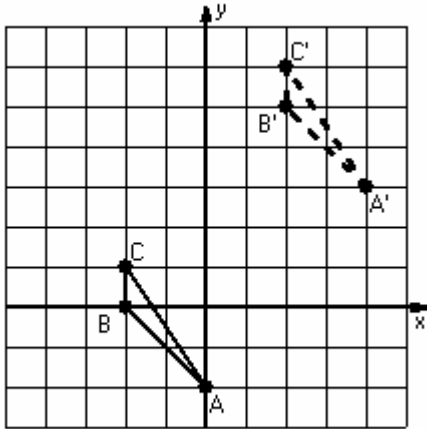

4) Translation $(-1, 2)$

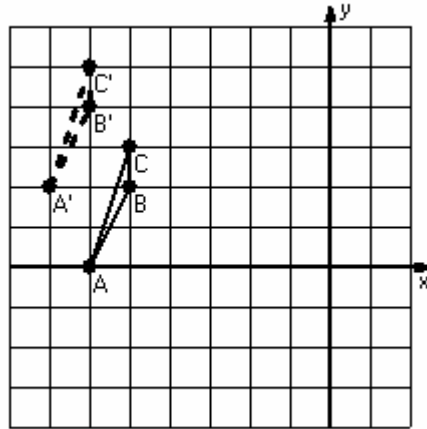

5) Translation $(-1, 2)$

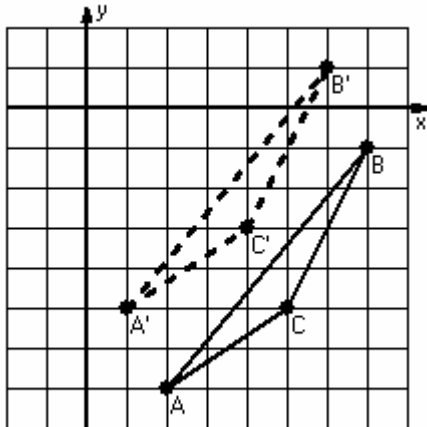

6) Translation $(-3, 1)$

