

# Angle Bisectors (E)

Construct the bisector for each angle.

1.

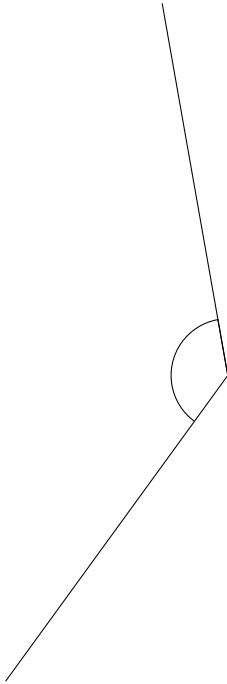

2.

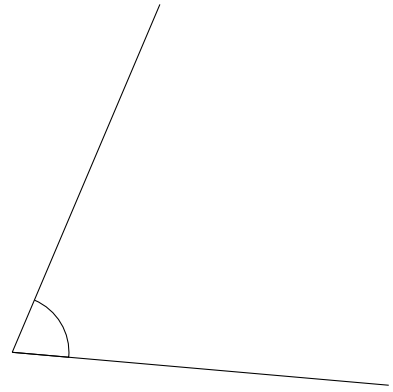

3.

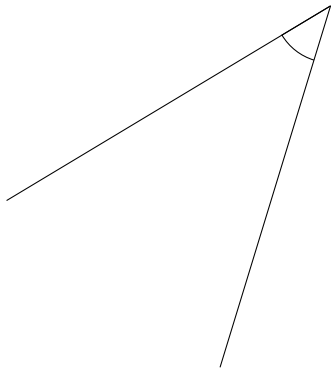

4.

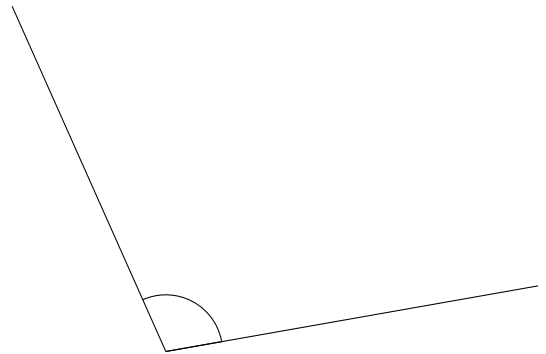

# Angle Bisectors (E) Answers

Construct the bisector for each angle.

1.

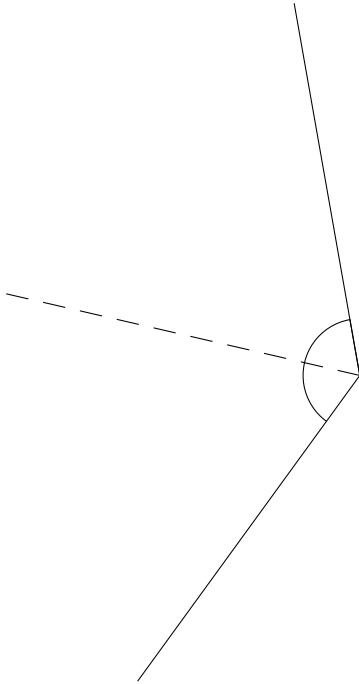

2.

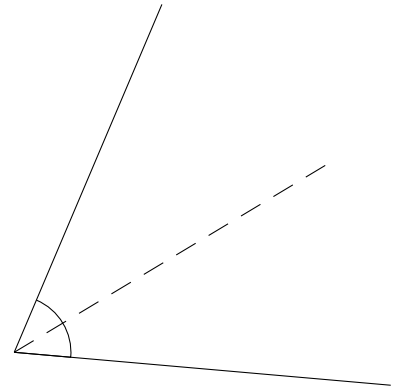

3.

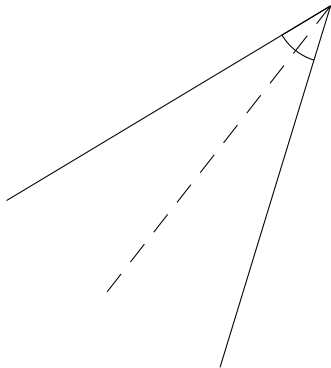

4.

