

# Corresponding Angles (A)

Find the corresponding angle measurements for the measured angles.

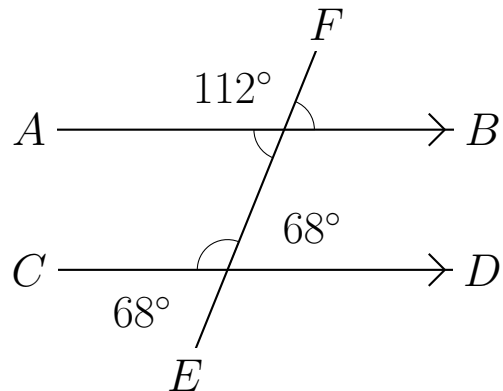
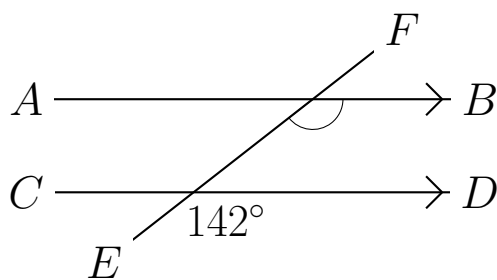
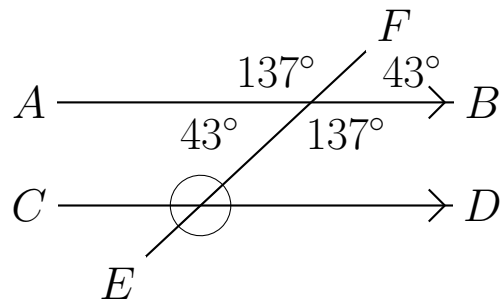
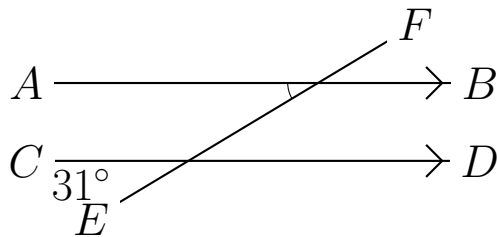
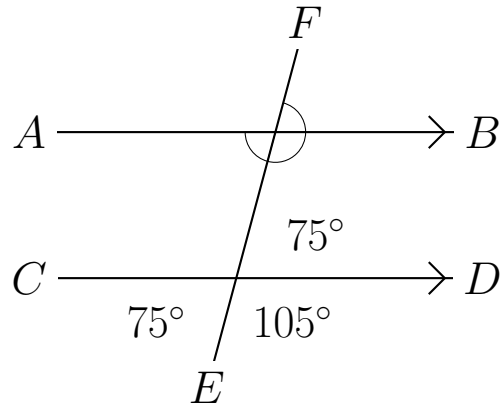
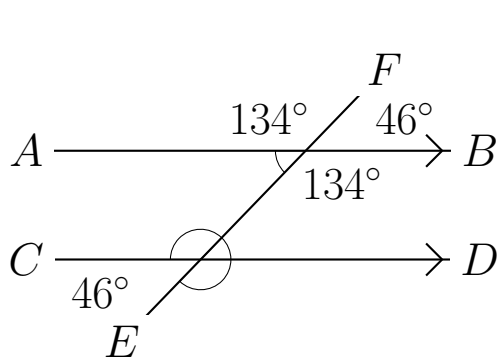

## Corresponding Angles (A) Answers

Find the corresponding angle measurements for the measured angles.

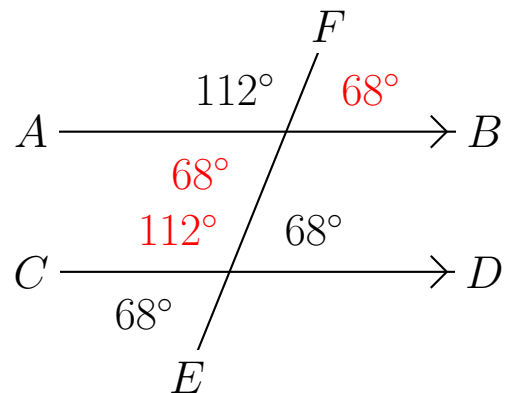
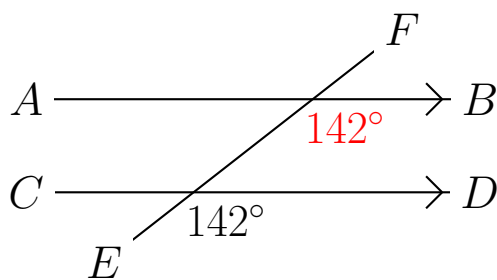
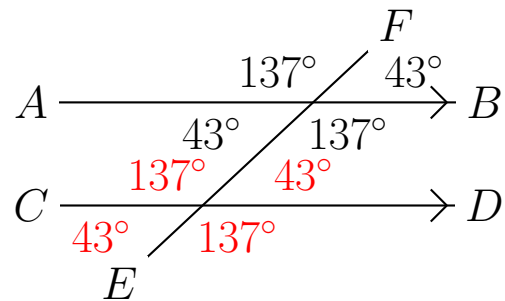
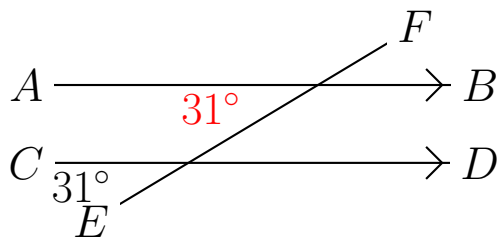
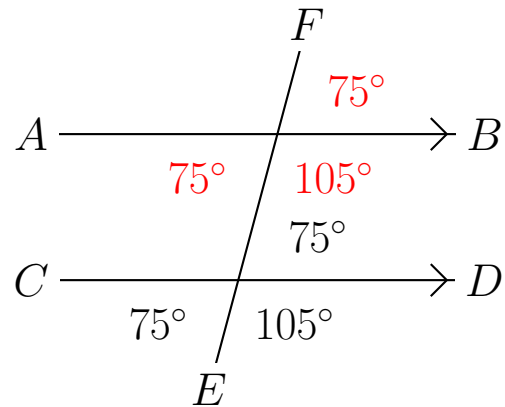
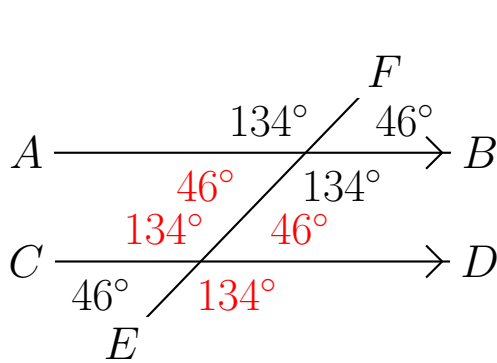

## Corresponding Angles (B)

Find the corresponding angle measurements for the measured angles.

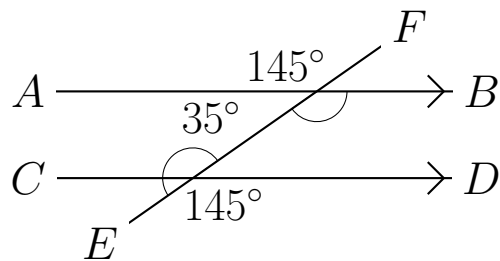
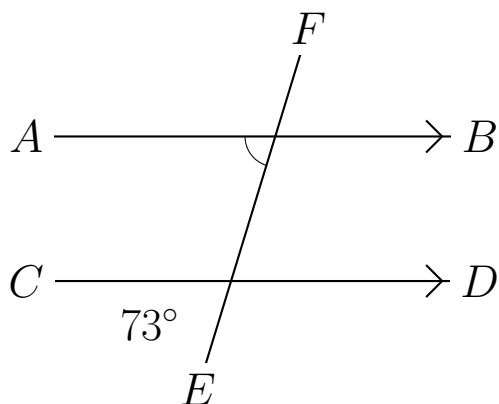
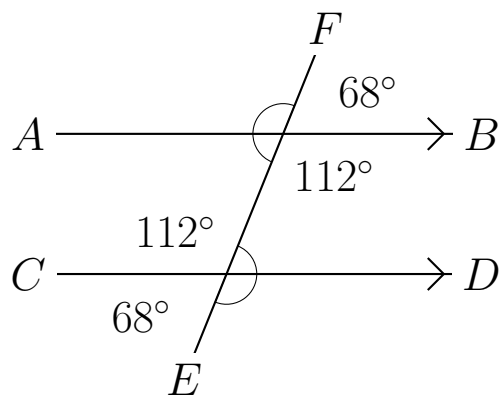
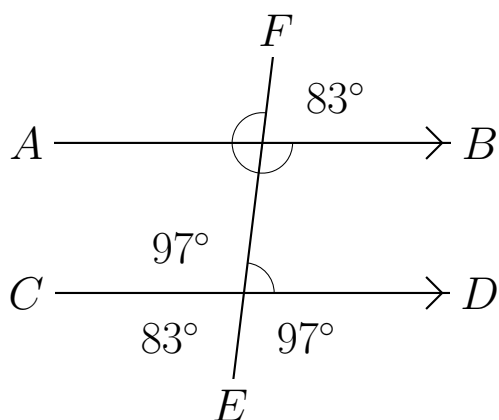
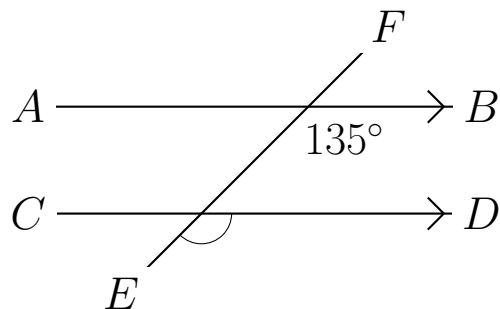
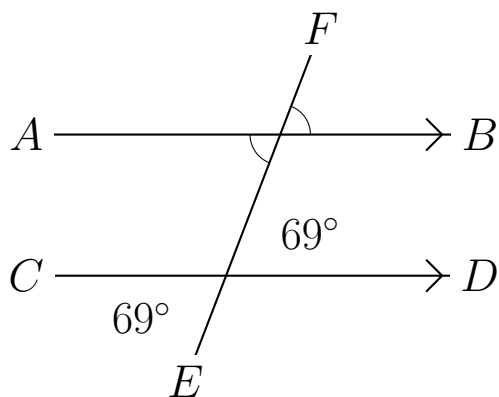

## Corresponding Angles (B) Answers

Find the corresponding angle measurements for the measured angles.

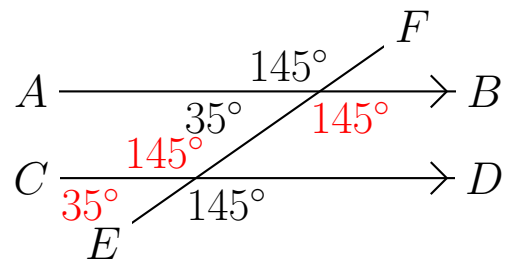
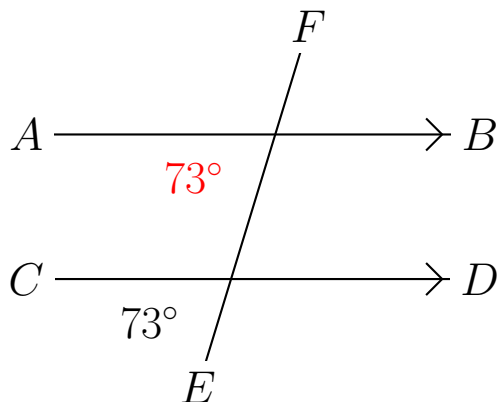
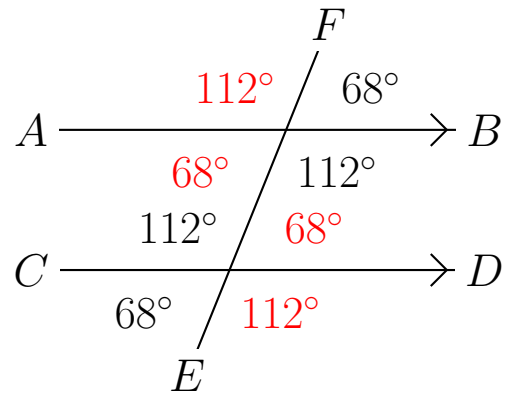
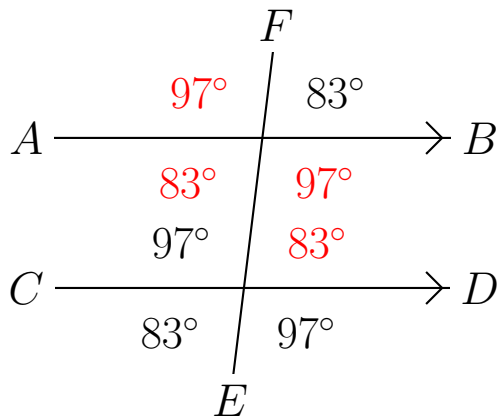
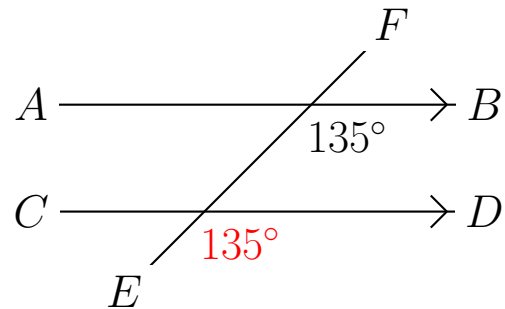
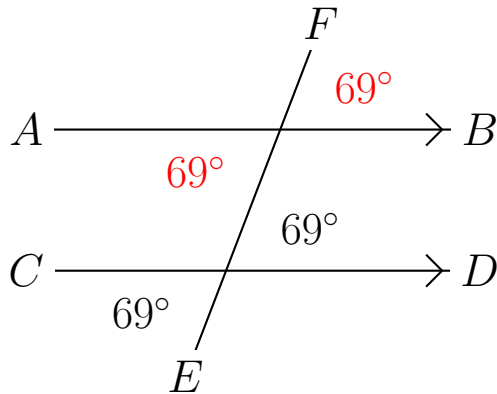

## Corresponding Angles (C)

Find the corresponding angle measurements for the measured angles.

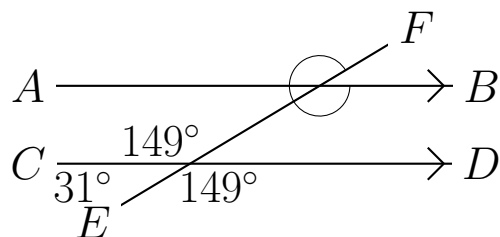
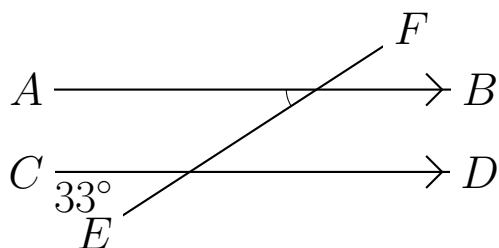
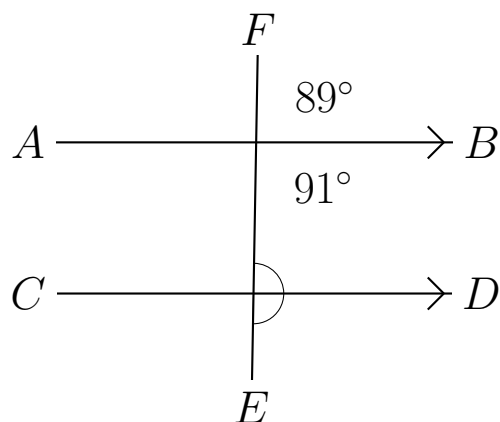
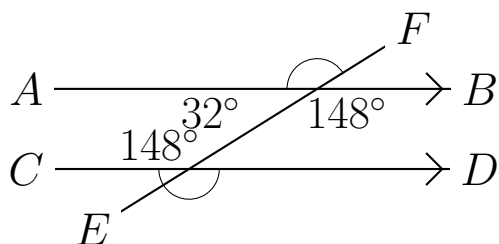
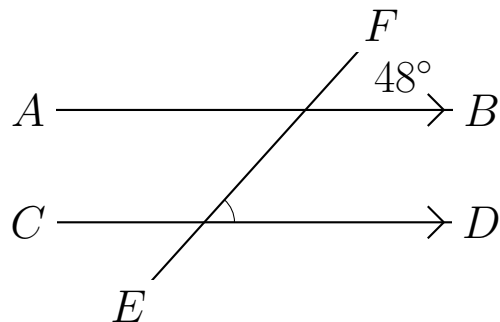
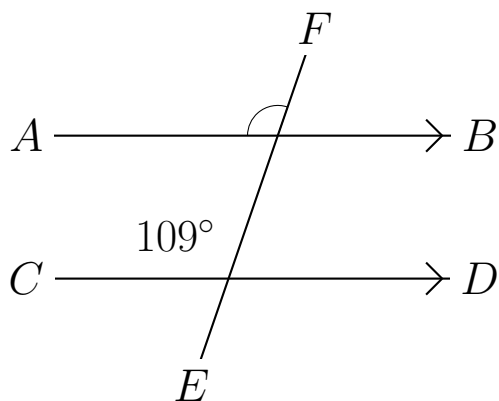

## Corresponding Angles (C) Answers

Find the corresponding angle measurements for the measured angles.

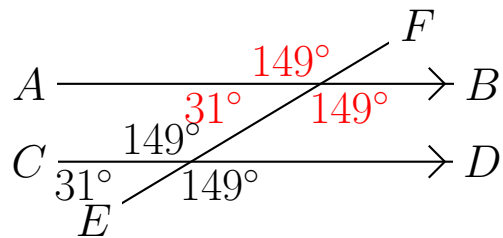
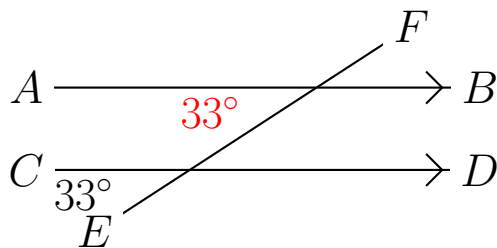
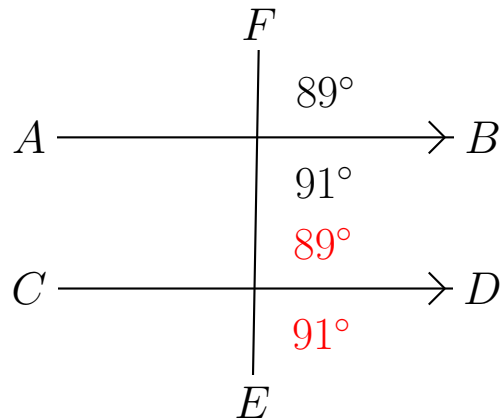
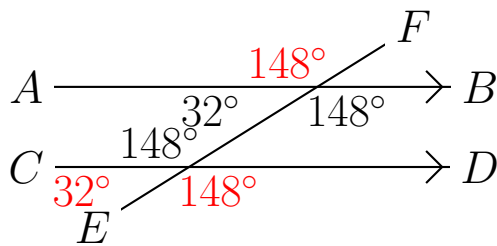
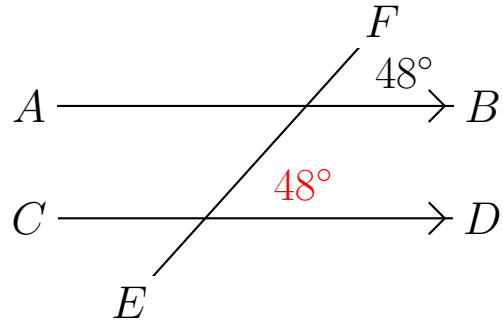
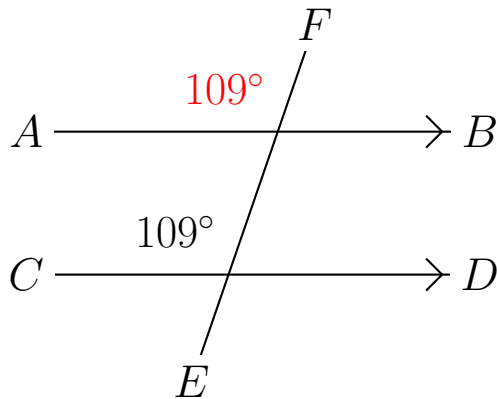

## Corresponding Angles (D)

Find the corresponding angle measurements for the measured angles.

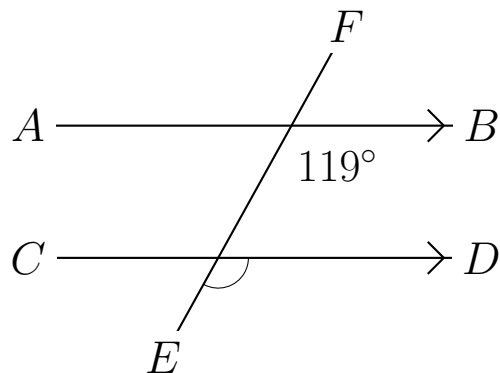
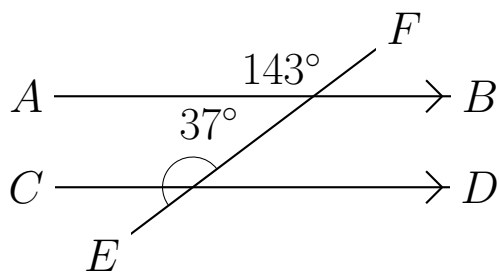
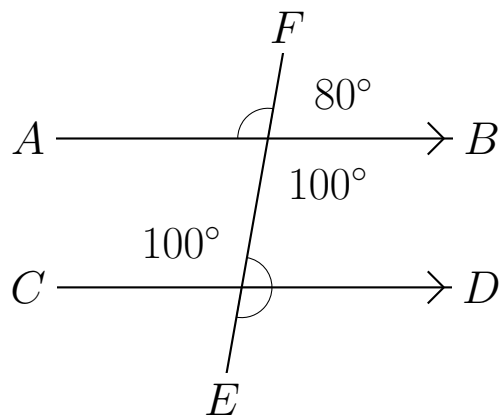
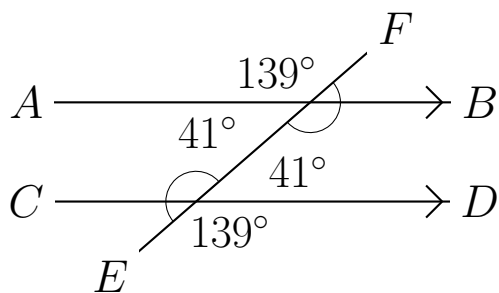
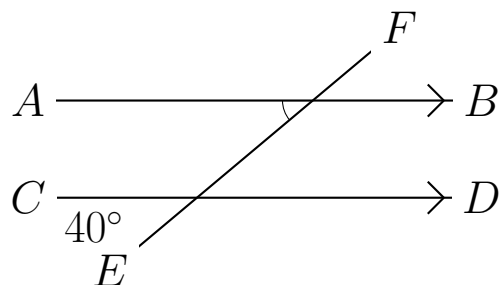
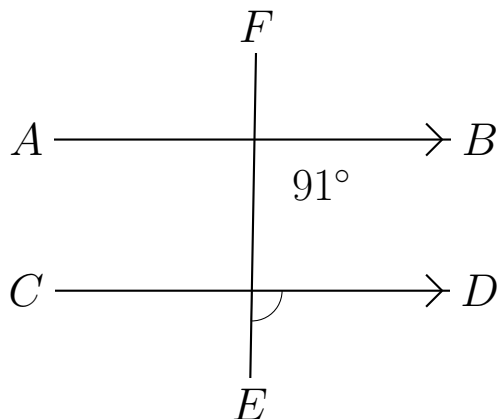

## Corresponding Angles (D) Answers

Find the corresponding angle measurements for the measured angles.

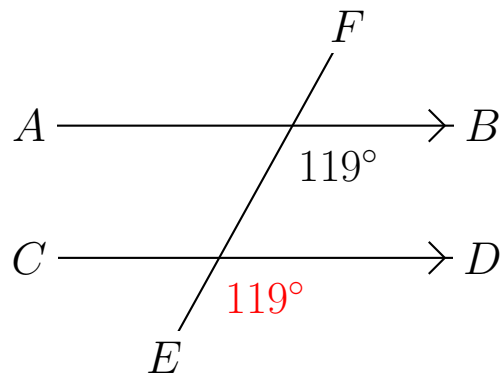
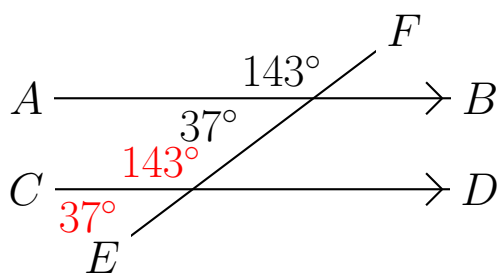
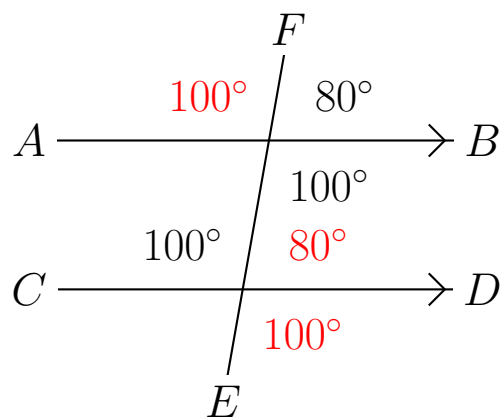
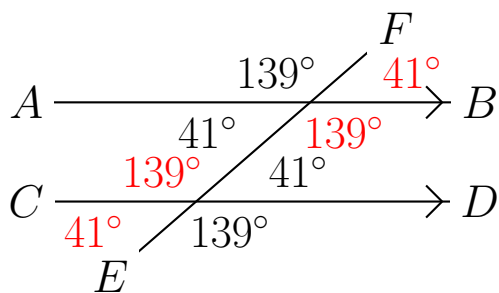
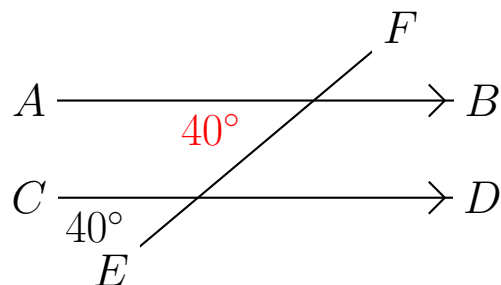
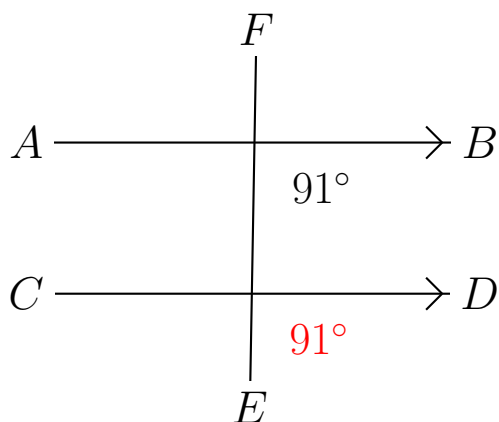



## Corresponding Angles (E)

Find the corresponding angle measurements for the measured angles.

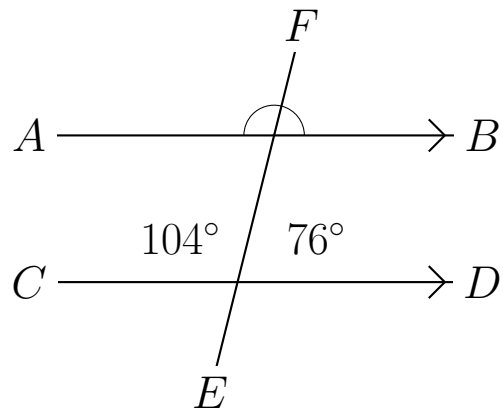
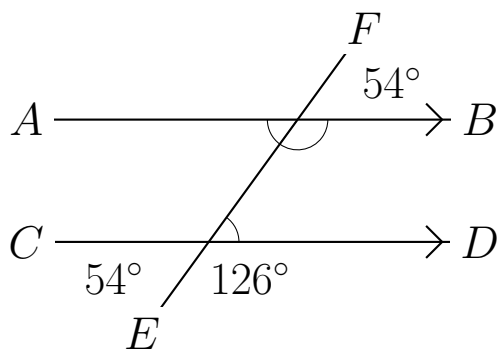
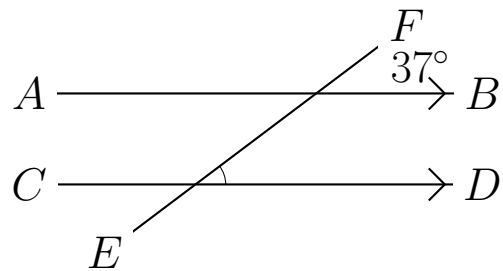
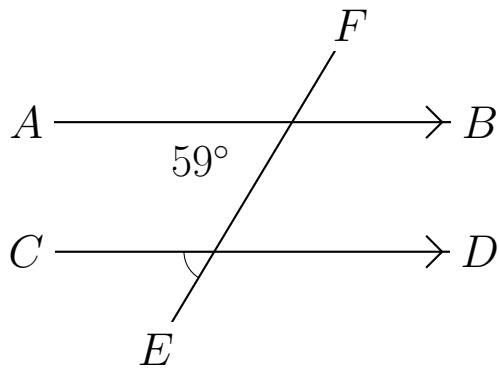
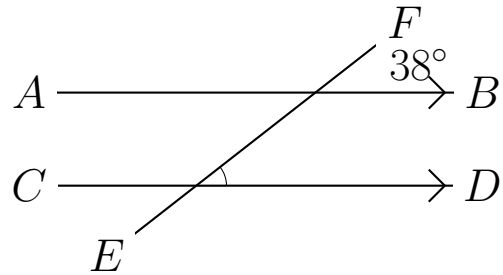
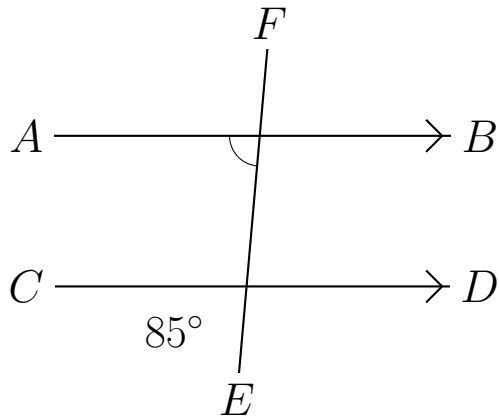

## Corresponding Angles (E) Answers

Find the corresponding angle measurements for the measured angles.

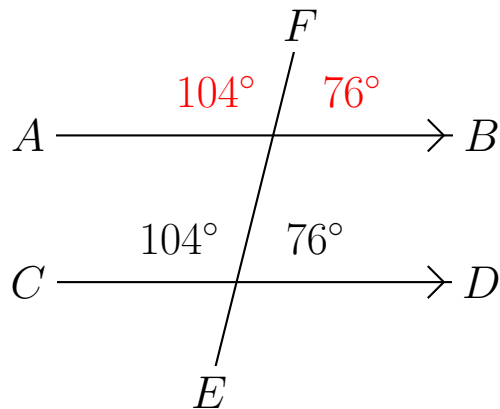
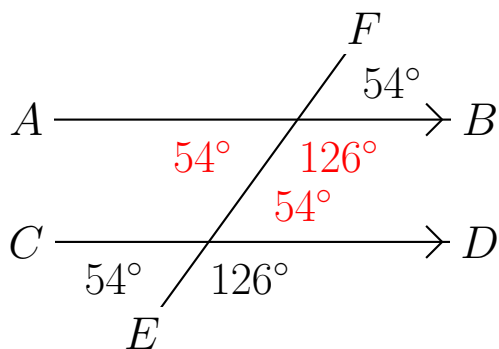
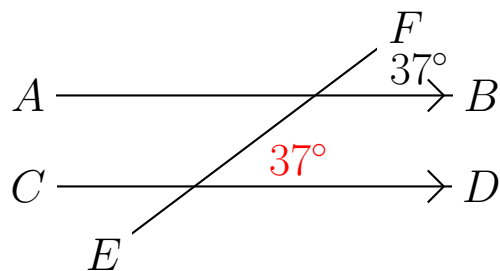
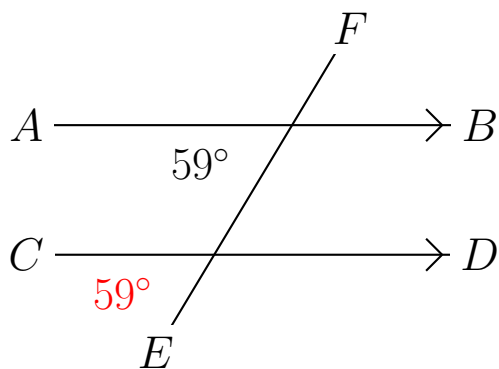
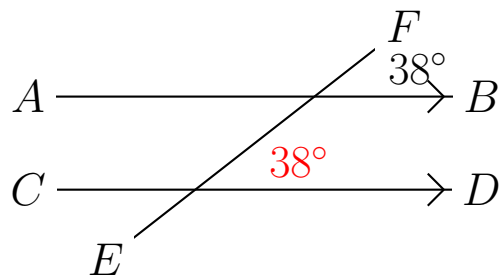
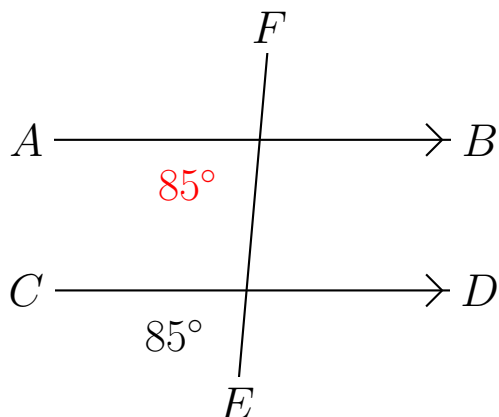

## Corresponding Angles (F)

Find the corresponding angle measurements for the measured angles.

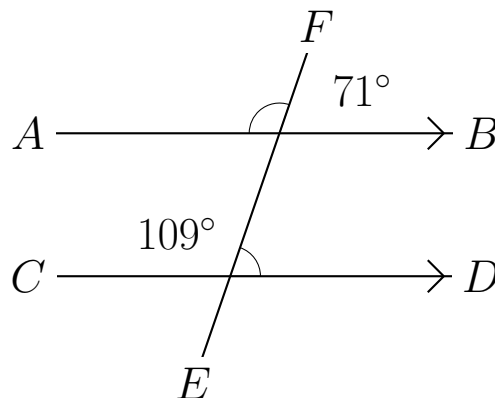
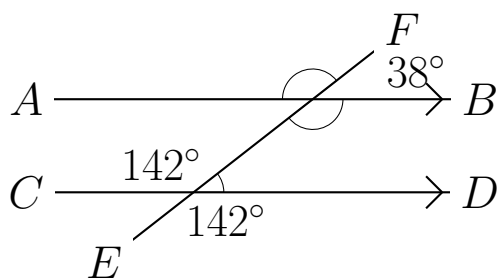
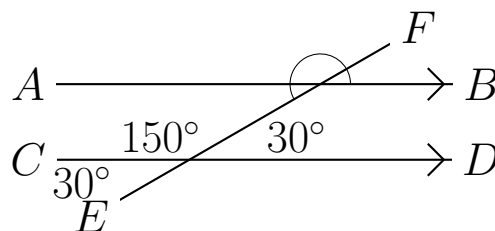
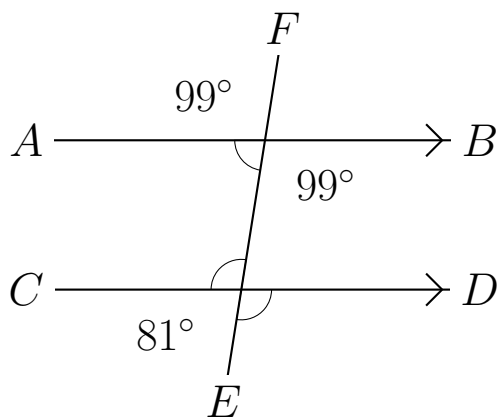
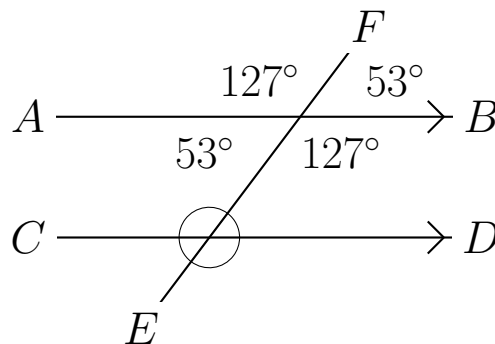
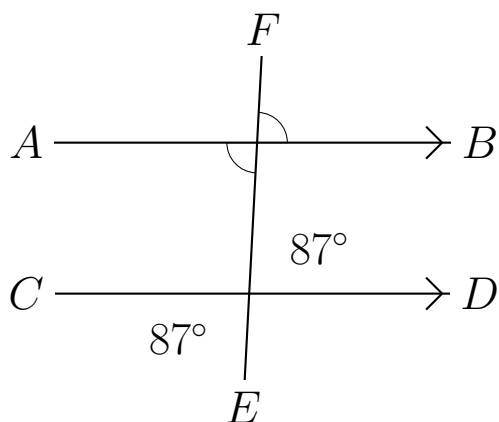

## Corresponding Angles (F) Answers

Find the corresponding angle measurements for the measured angles.

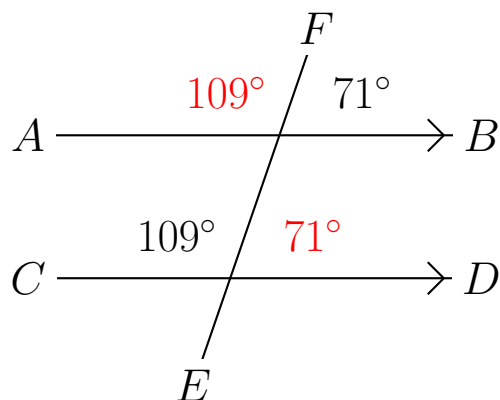
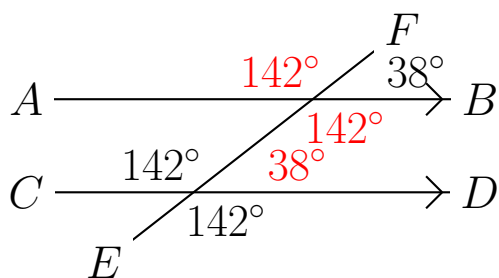
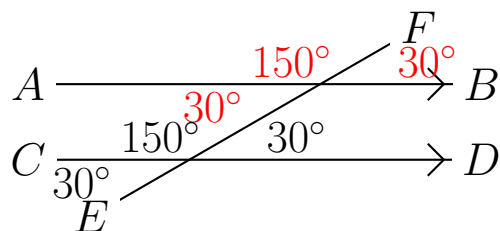
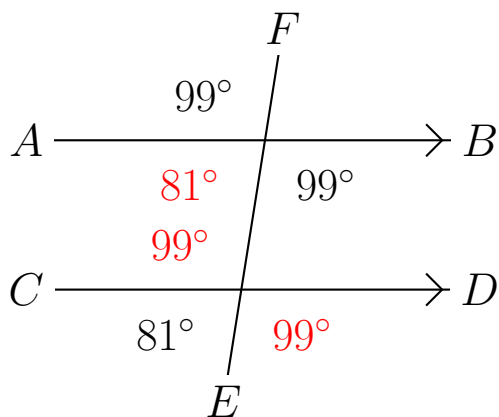
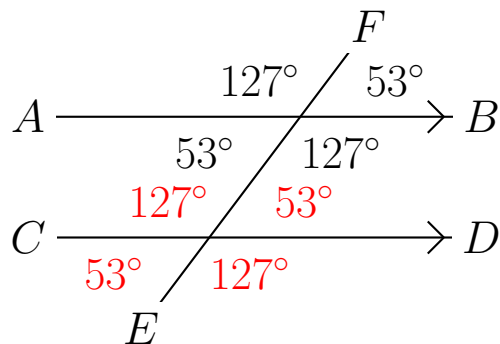
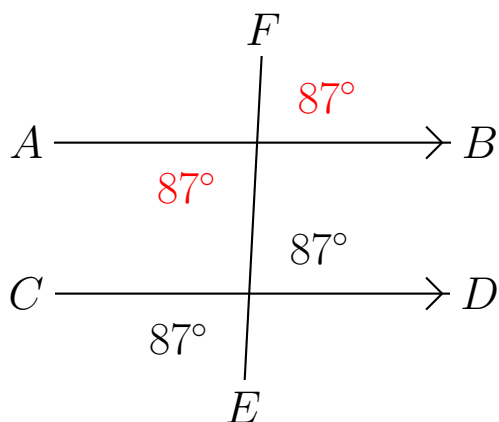

## Corresponding Angles (G)

Find the corresponding angle measurements for the measured angles.

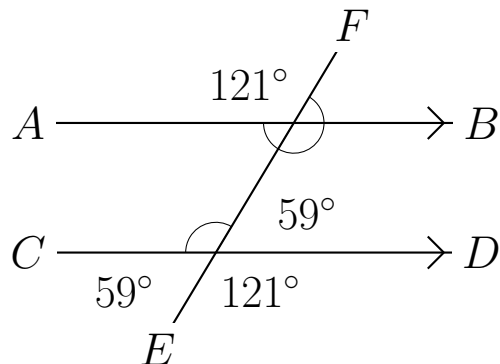
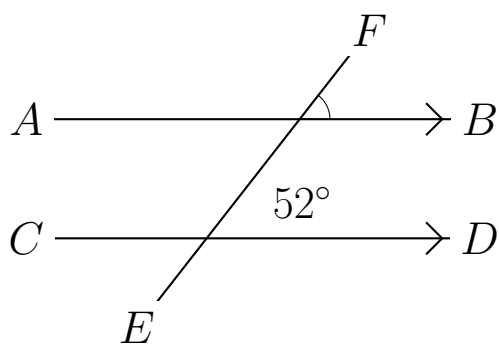
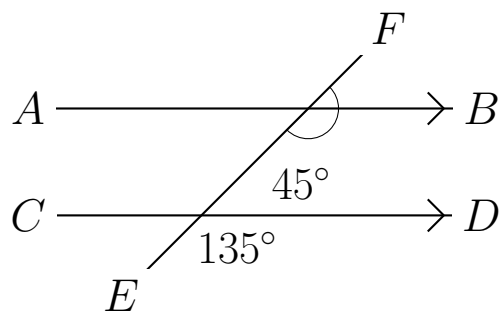
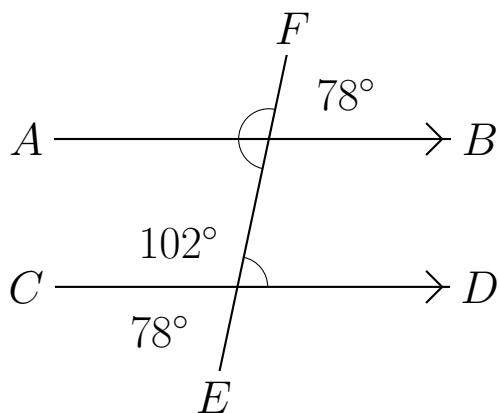
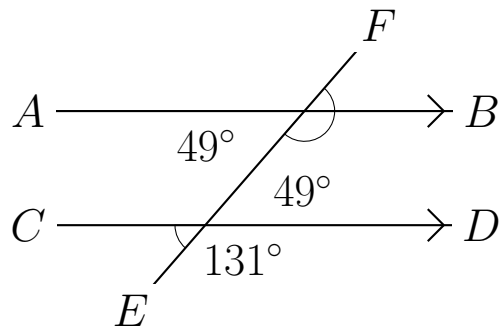
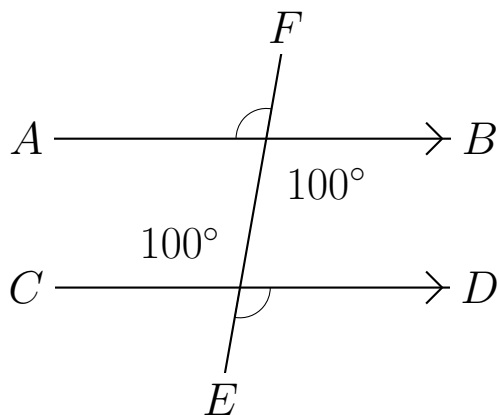

## Corresponding Angles (G) Answers

Find the corresponding angle measurements for the measured angles.

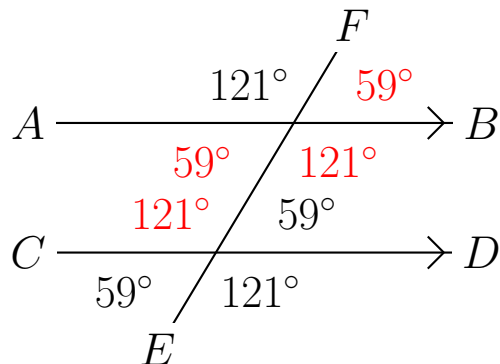
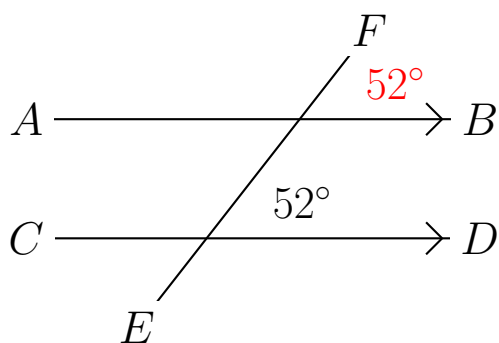
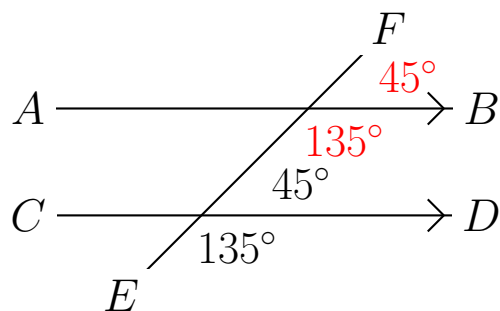
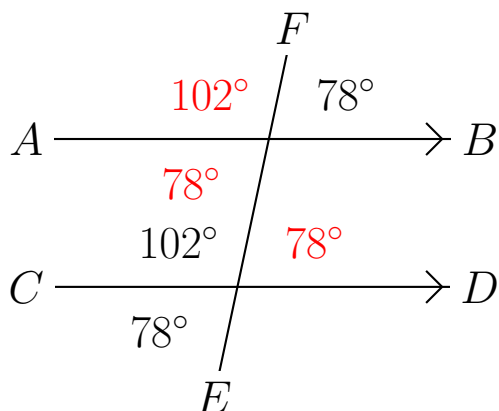
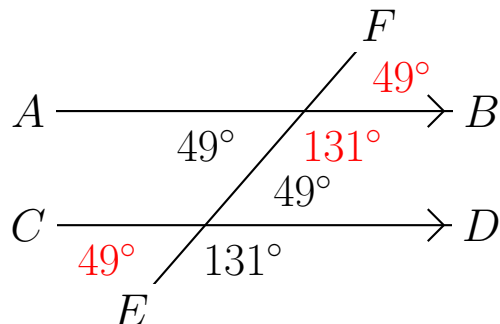
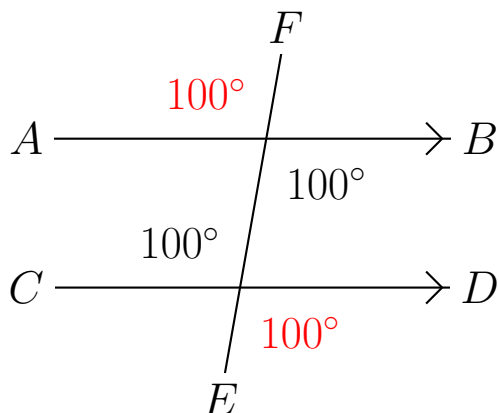

## Corresponding Angles (H)

Find the corresponding angle measurements for the measured angles.

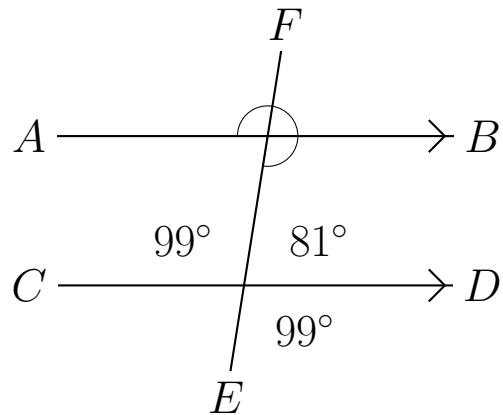
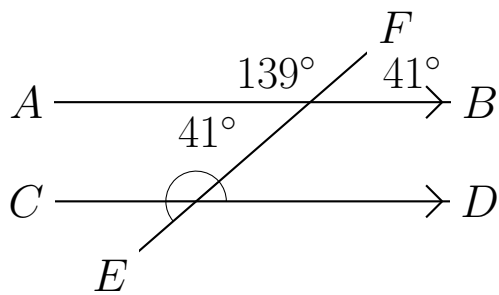
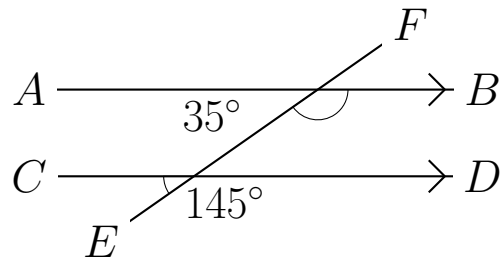
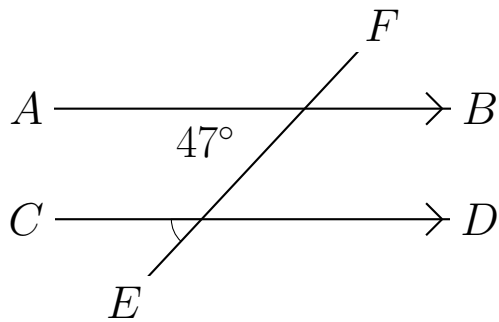
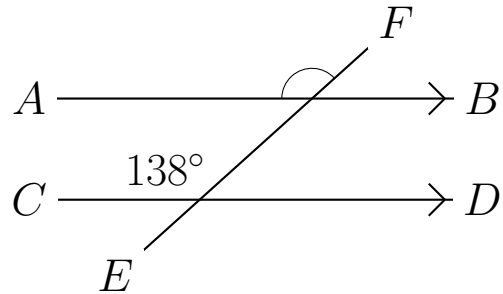
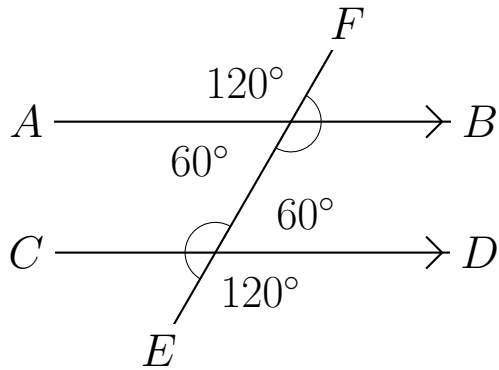

## Corresponding Angles (H) Answers

Find the corresponding angle measurements for the measured angles.

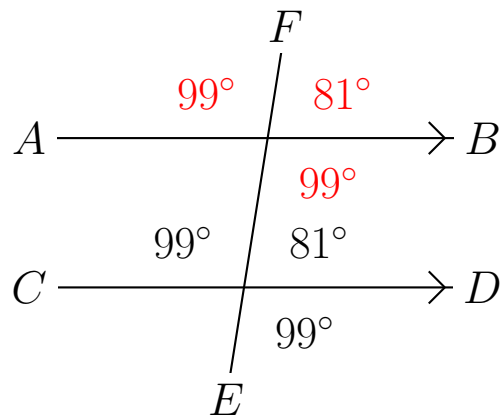
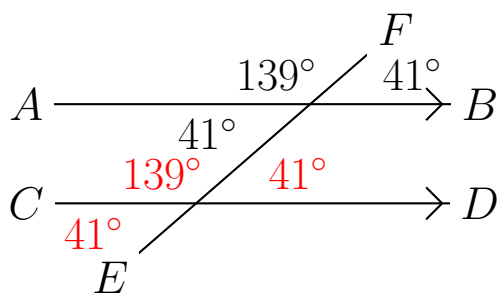
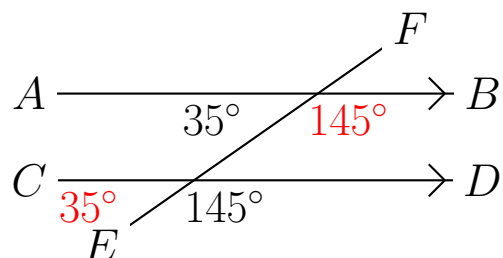
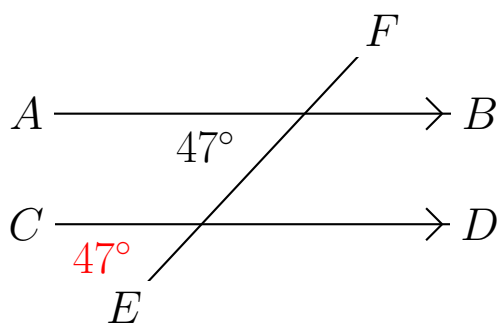
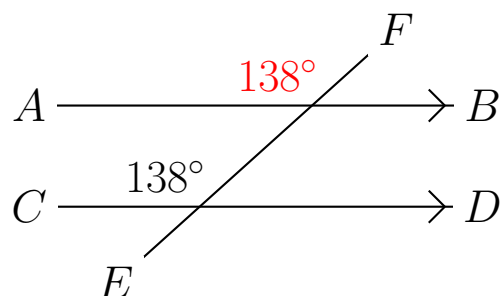
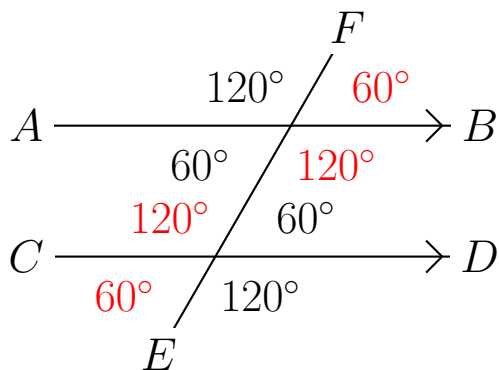



# Corresponding Angles (I)

Find the corresponding angle measurements for the measured angles.

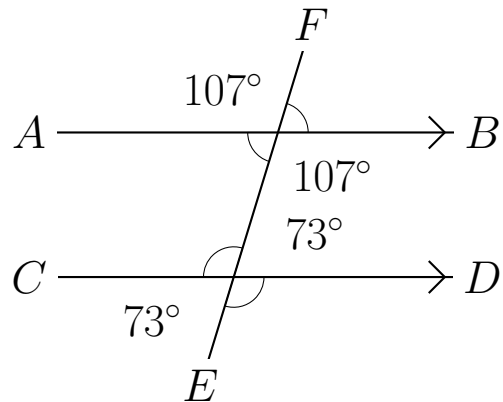
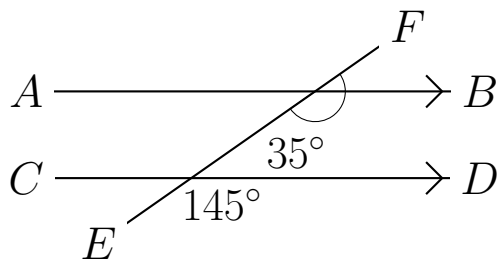
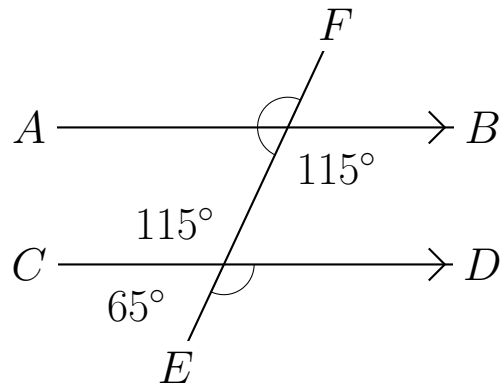
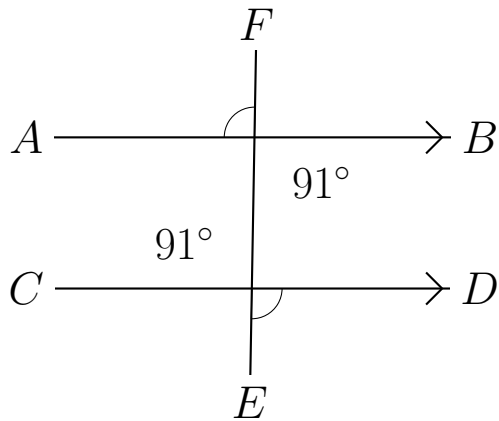
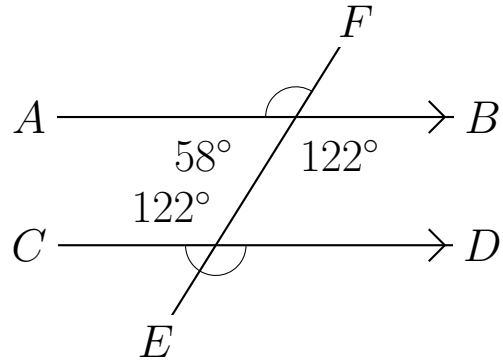
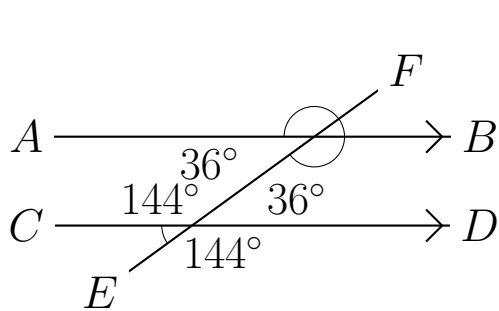

# Corresponding Angles (I) Answers

Find the corresponding angle measurements for the measured angles.

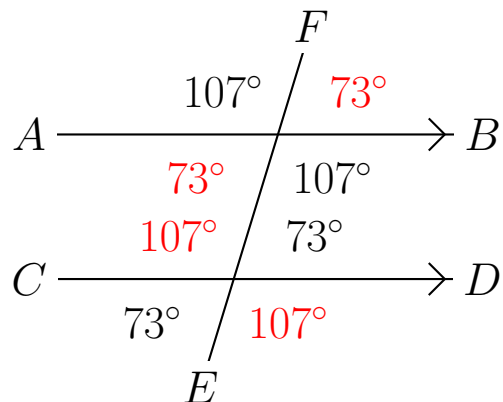
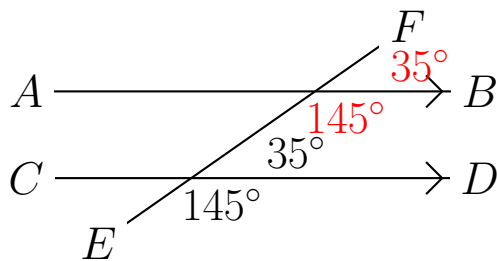
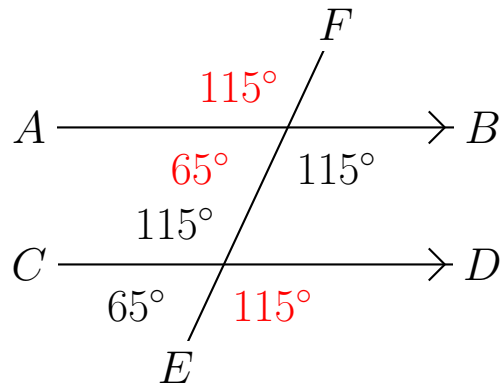
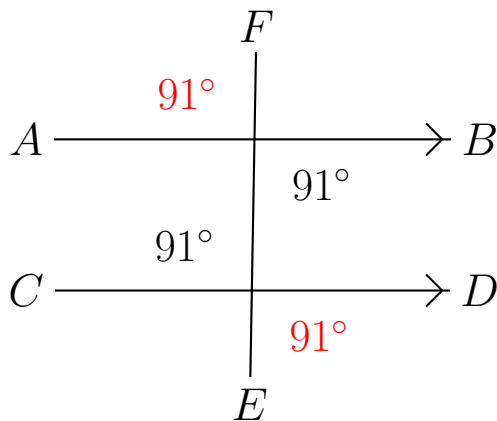
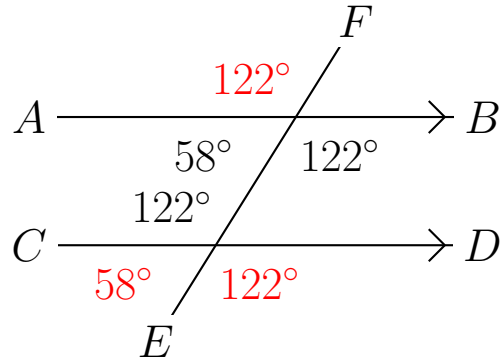
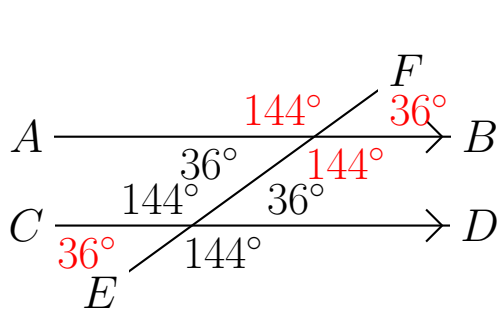

## Corresponding Angles (J)

Find the corresponding angle measurements for the measured angles.

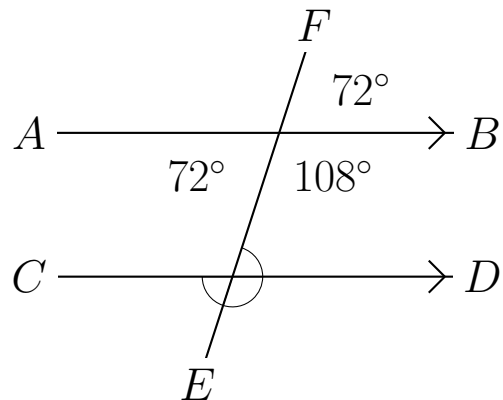
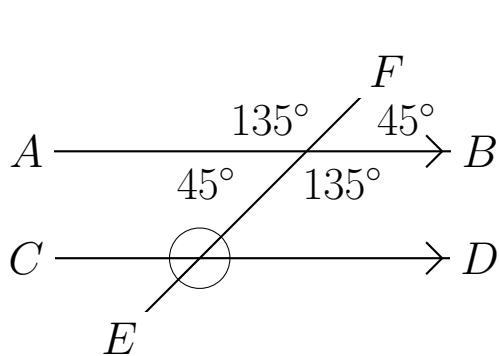
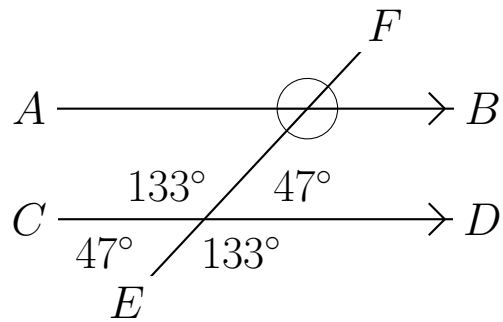
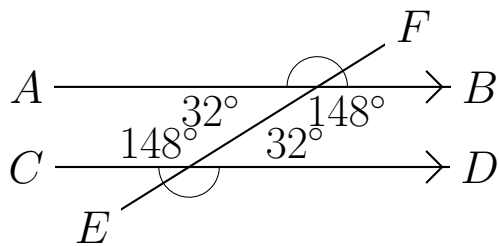
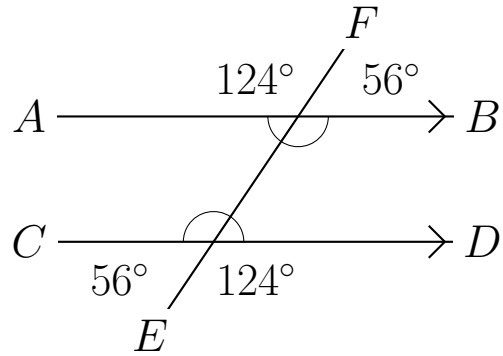
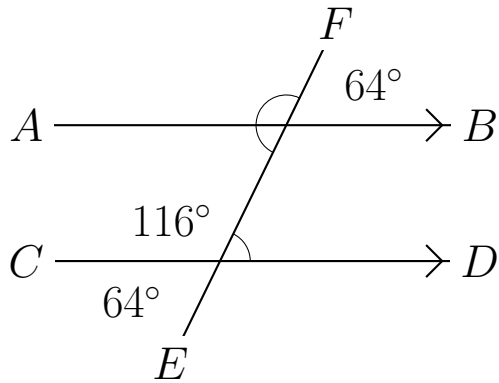

## Corresponding Angles (J) Answers

Find the corresponding angle measurements for the measured angles.

