

Interior Alternate Angles (A)

Find the alternate angle measurements for the measured angles.

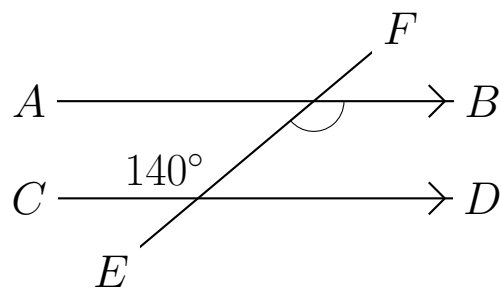
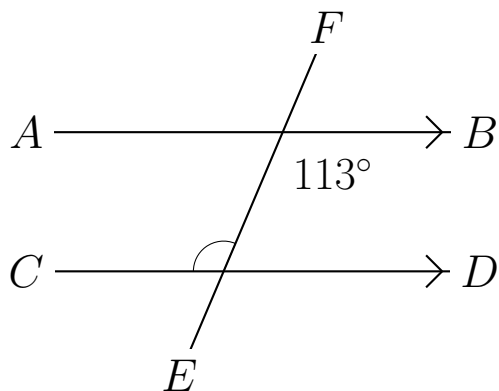
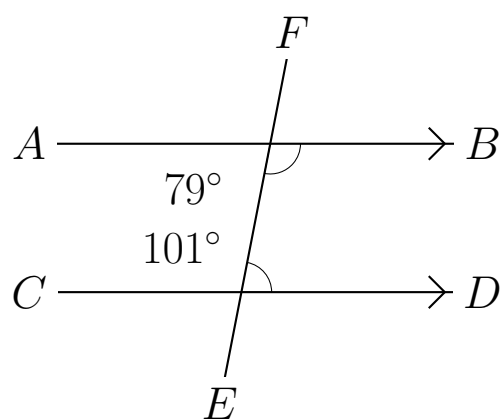
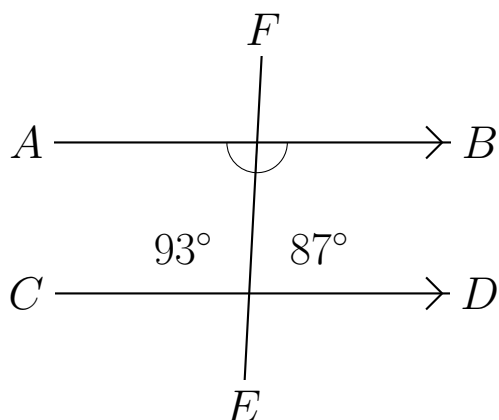
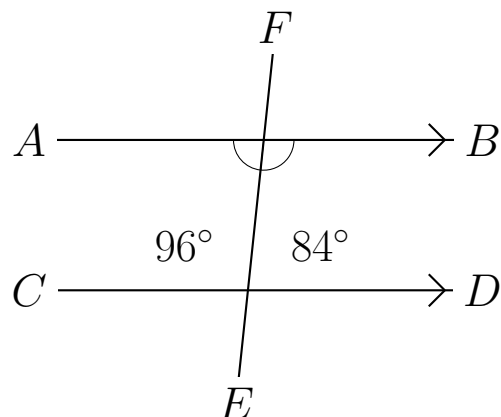
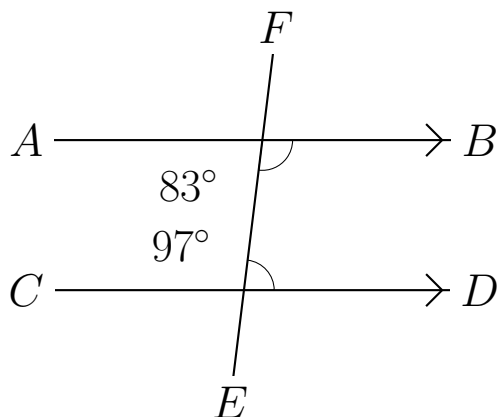

Interior Alternate Angles (A) Answers

Find the alternate angle measurements for the measured angles.

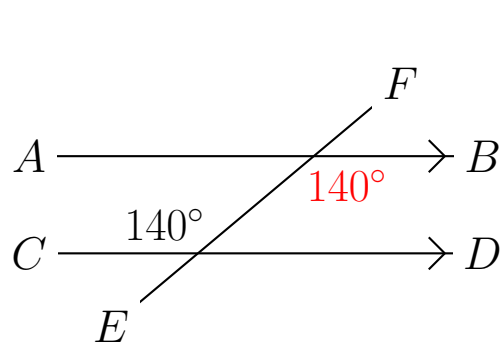
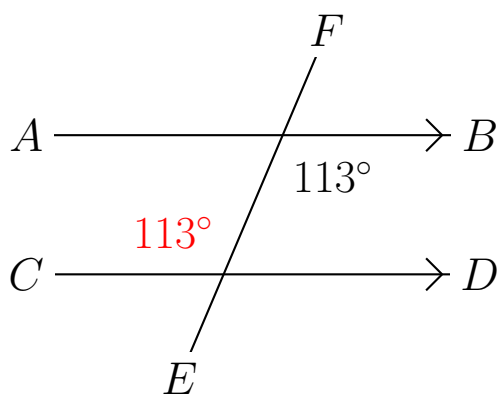
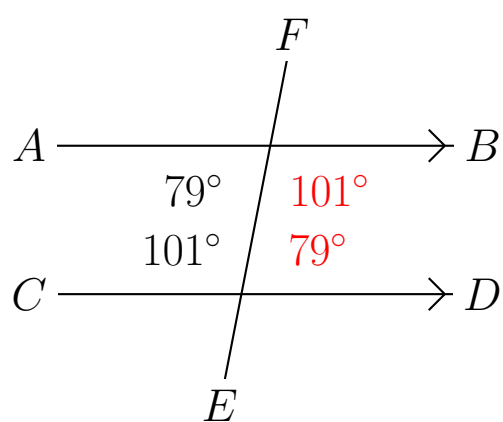
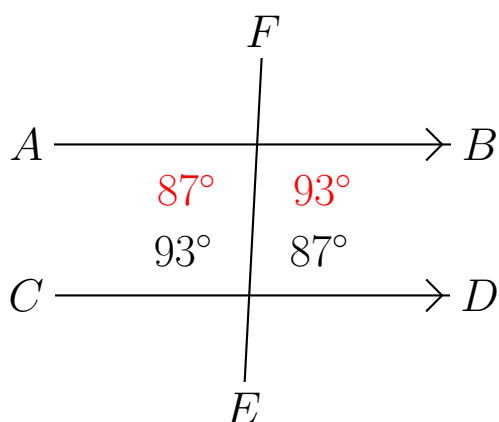
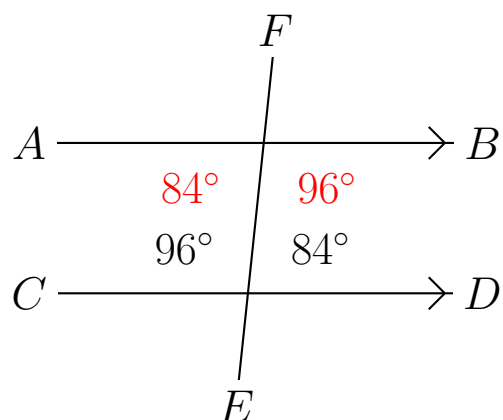
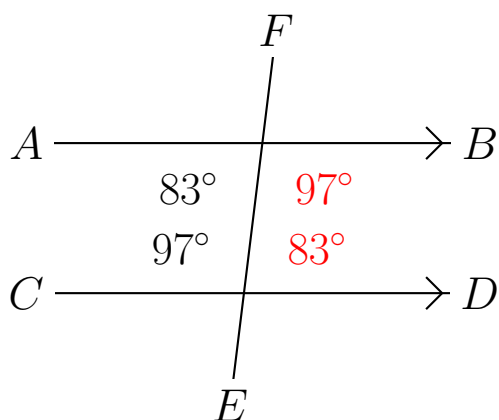

Interior Alternate Angles (B)

Find the alternate angle measurements for the measured angles.

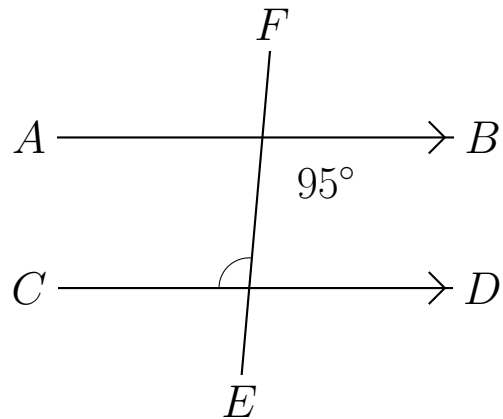
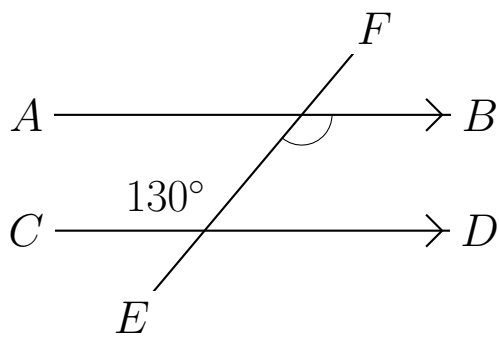
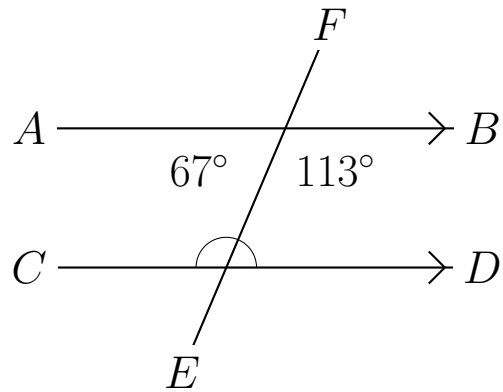
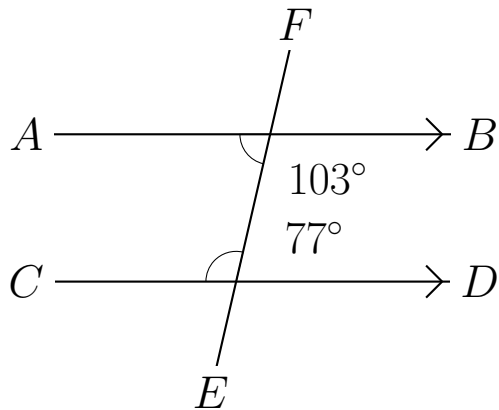
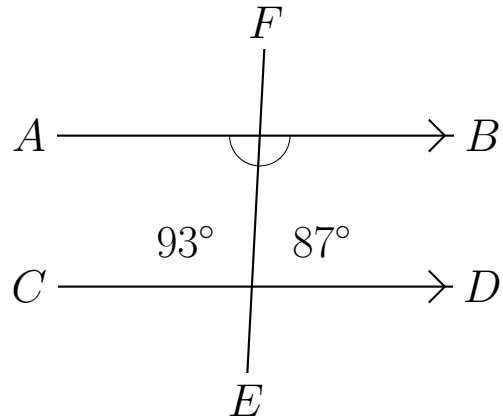
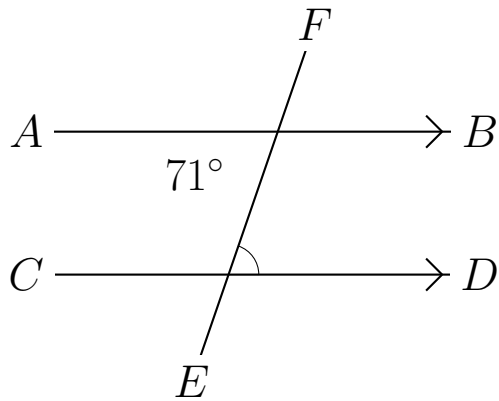

Interior Alternate Angles (B) Answers

Find the alternate angle measurements for the measured angles.

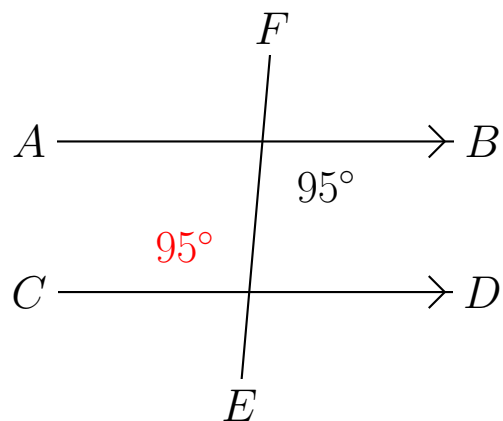
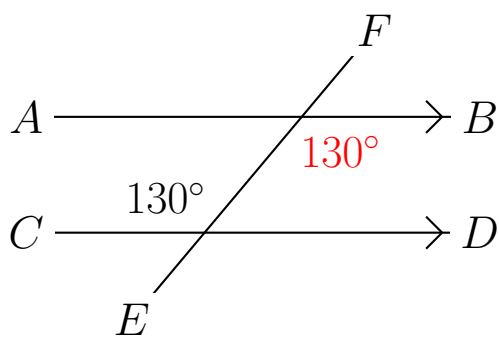
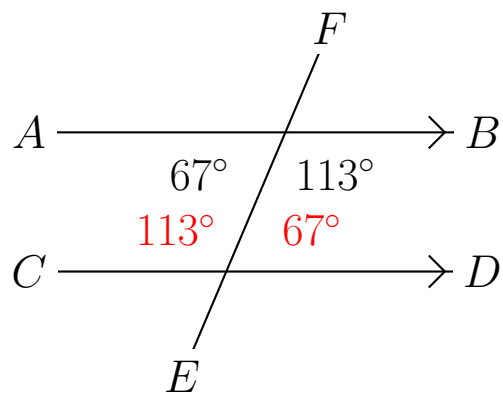
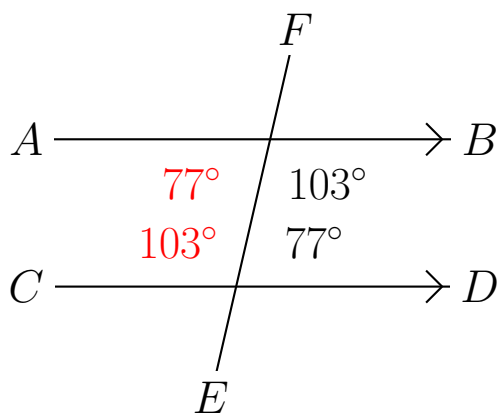
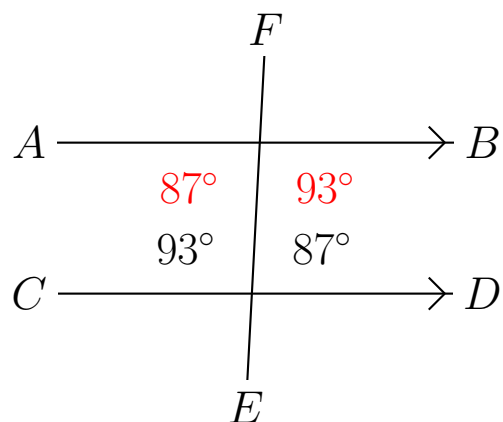
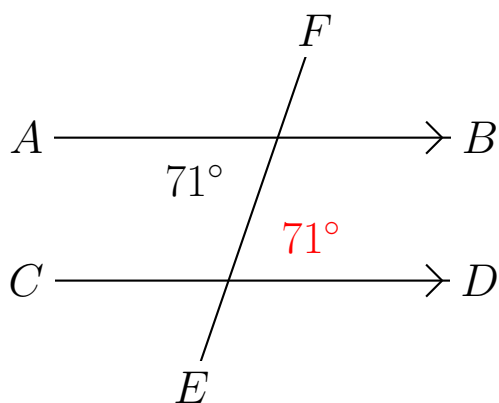

Interior Alternate Angles (C)

Find the alternate angle measurements for the measured angles.

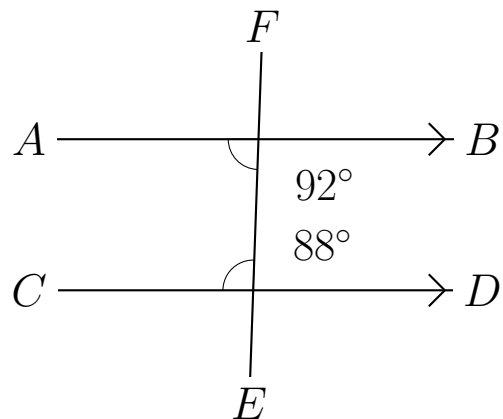
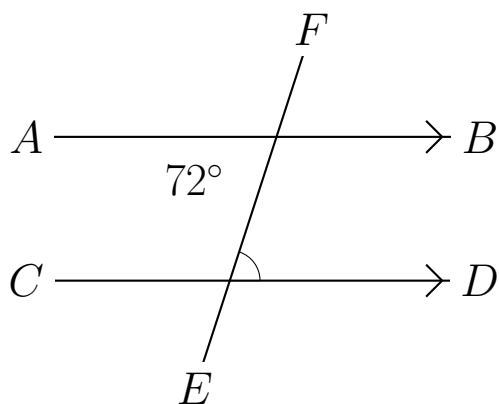
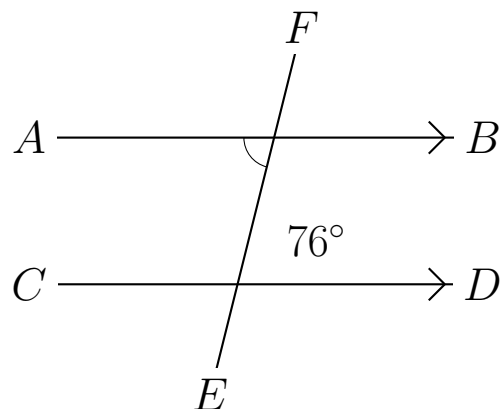
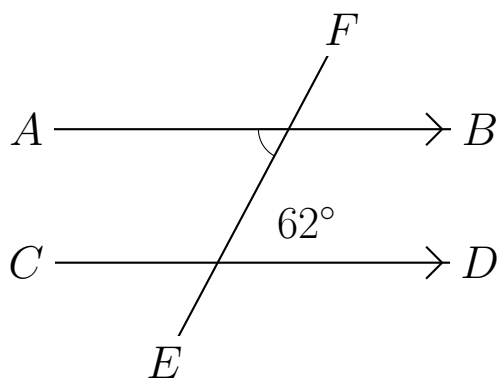
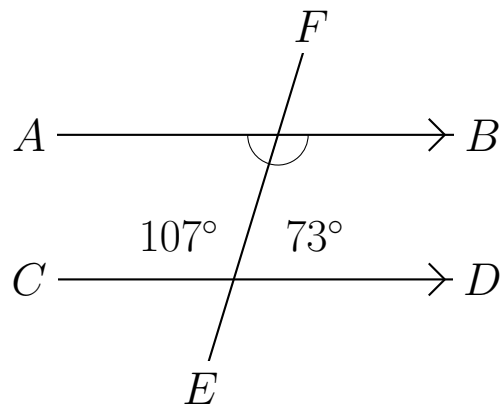
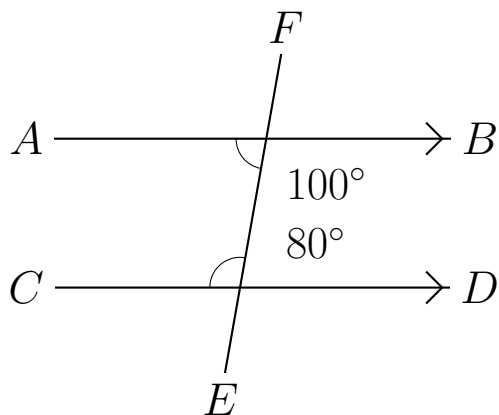

Interior Alternate Angles (C) Answers

Find the alternate angle measurements for the measured angles.

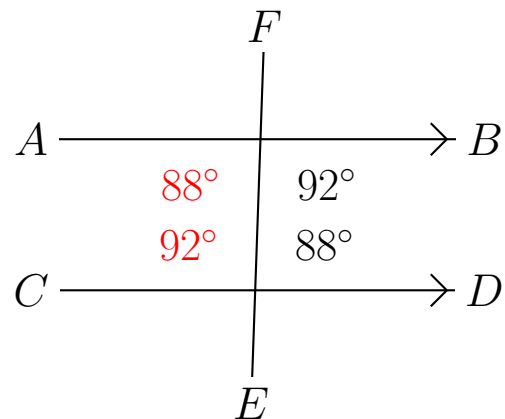
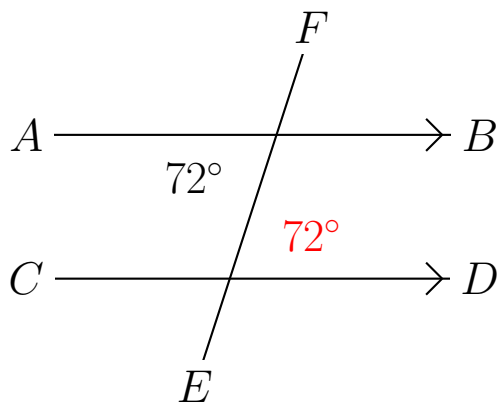
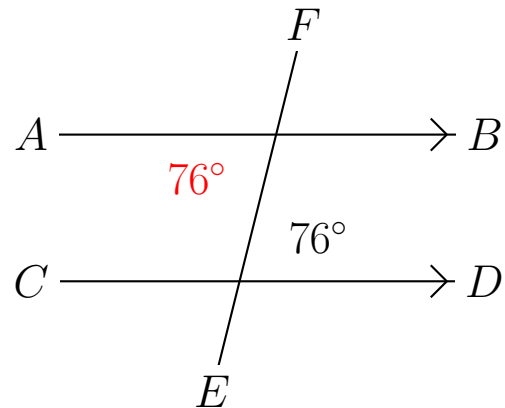
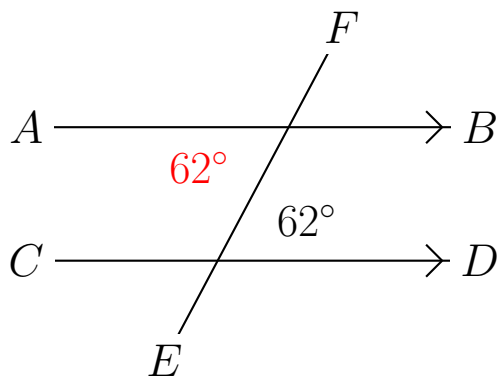
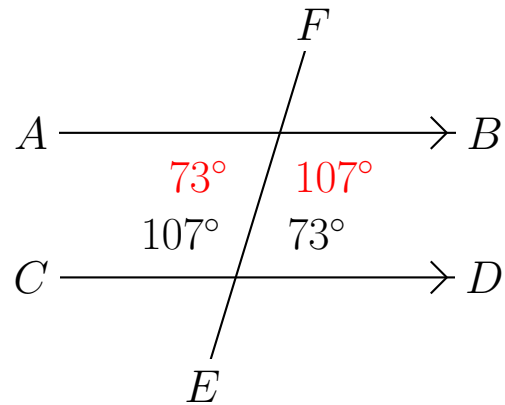
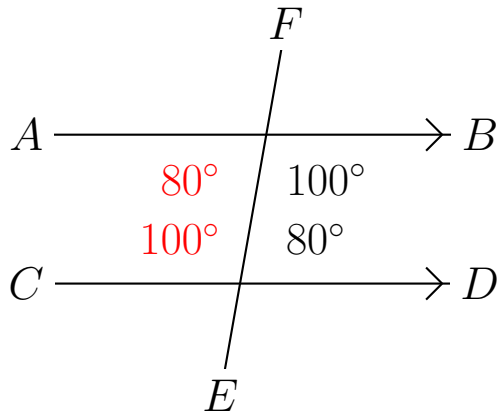

Interior Alternate Angles (D)

Find the alternate angle measurements for the measured angles.

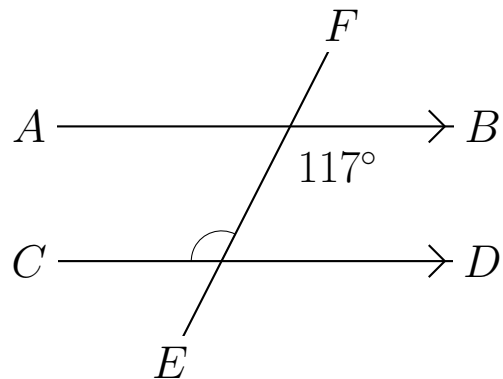
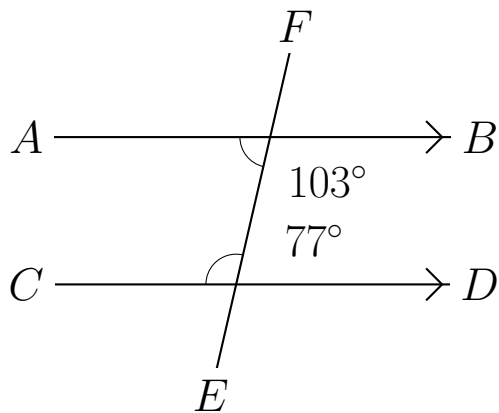
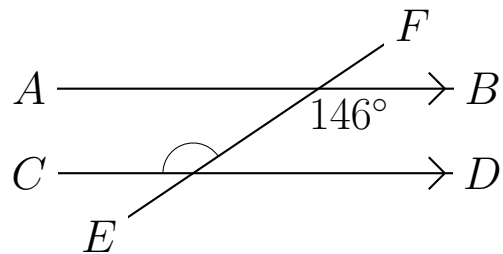
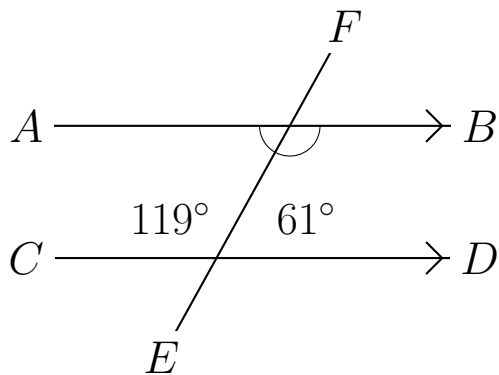
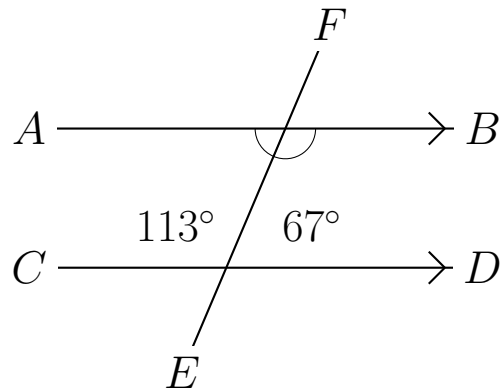
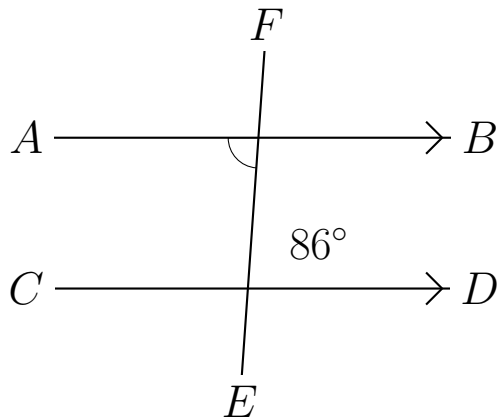

Interior Alternate Angles (D) Answers

Find the alternate angle measurements for the measured angles.

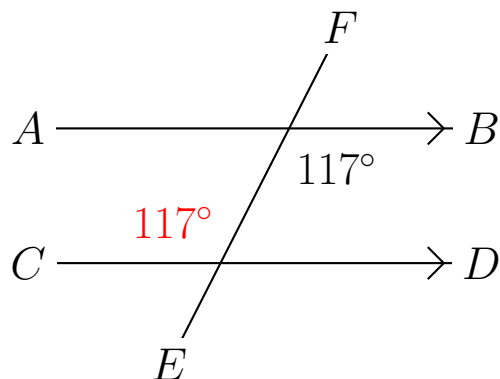
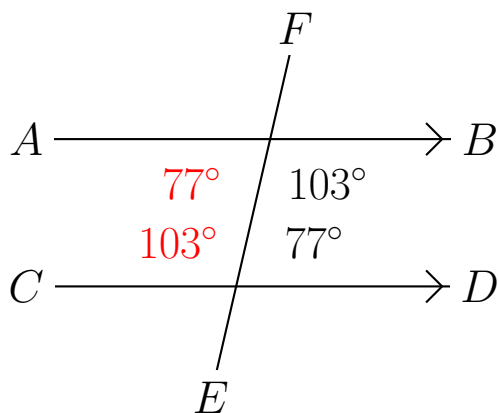
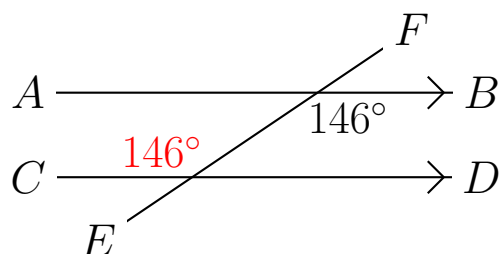
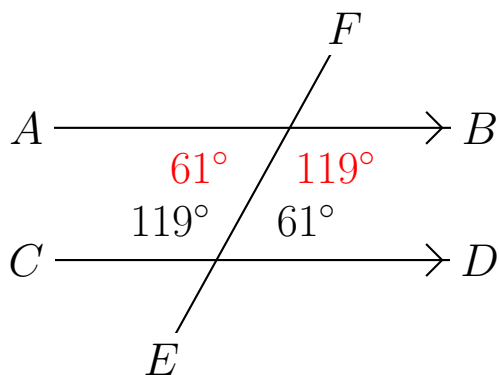
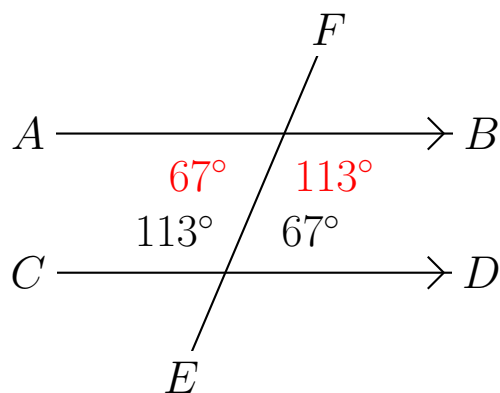
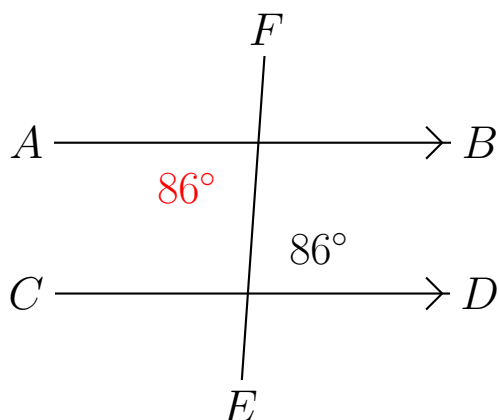

Interior Alternate Angles (E)

Find the alternate angle measurements for the measured angles.

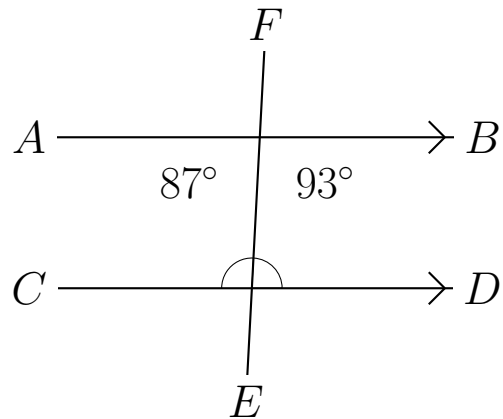
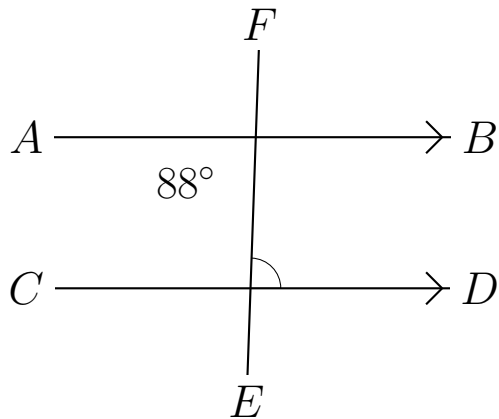
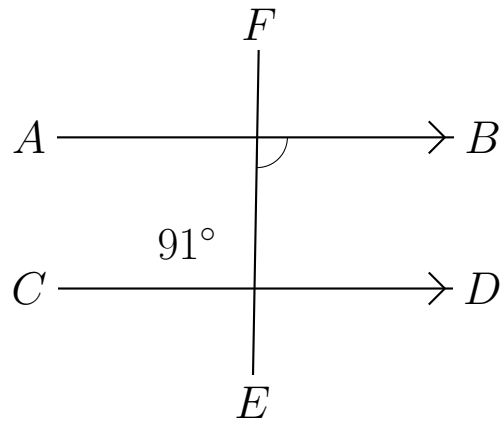
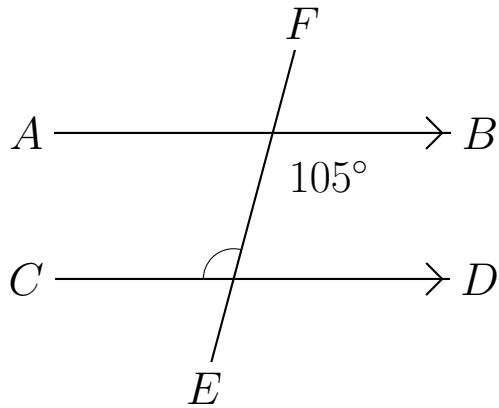
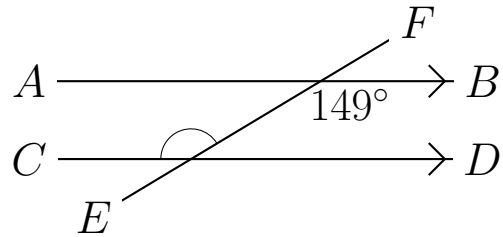
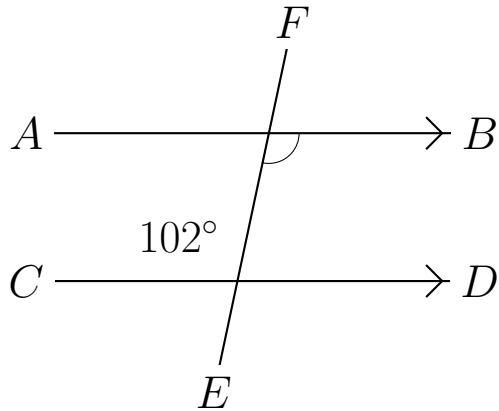

Interior Alternate Angles (E) Answers

Find the alternate angle measurements for the measured angles.

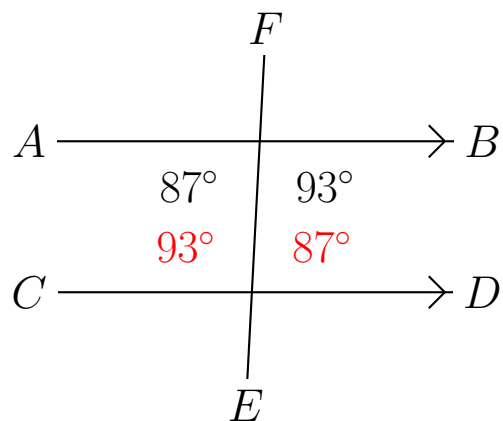
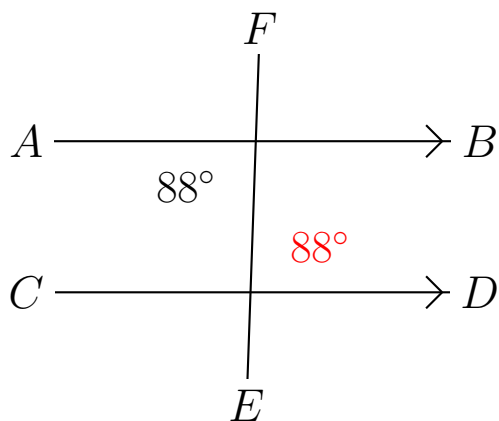
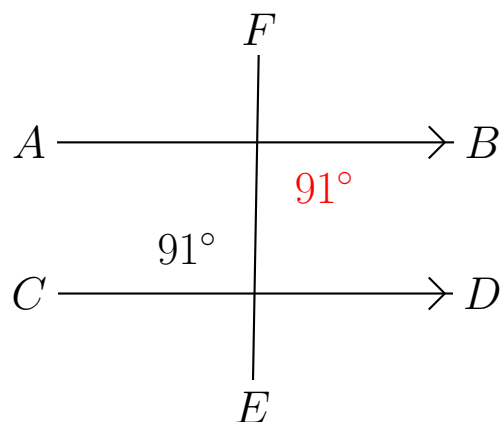
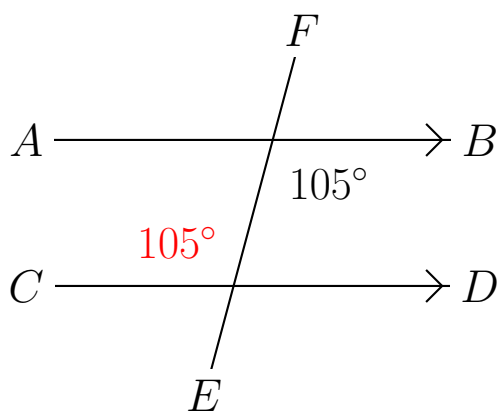
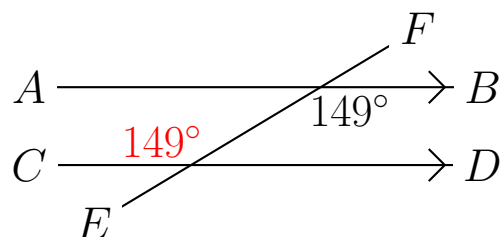
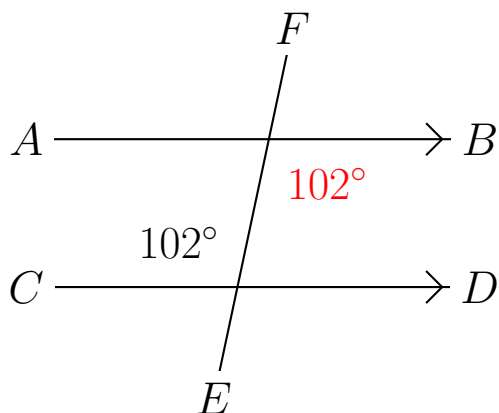

Interior Alternate Angles (F)

Find the alternate angle measurements for the measured angles.

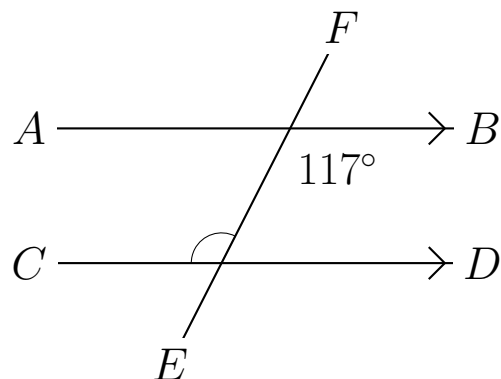
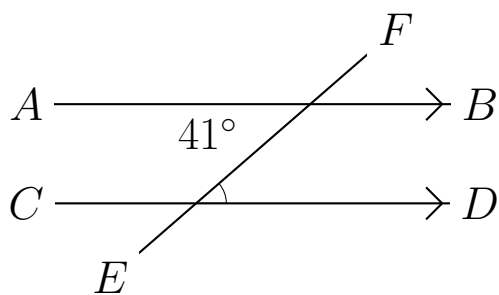
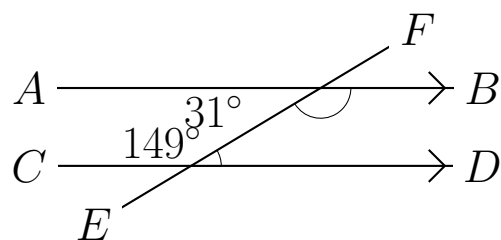
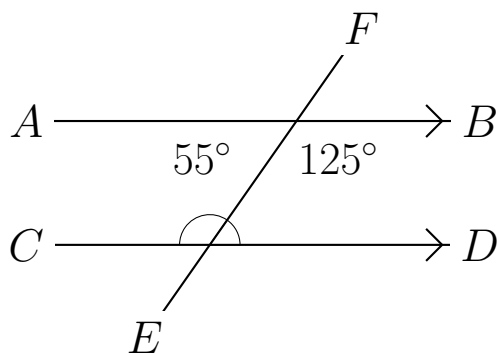
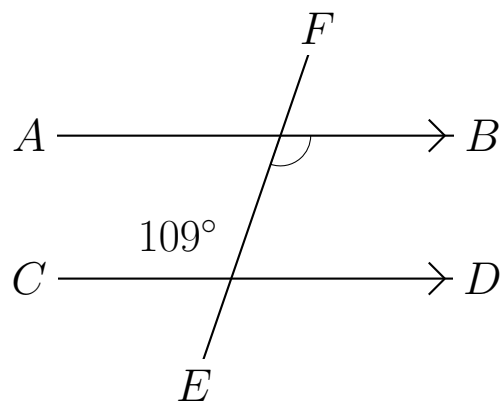
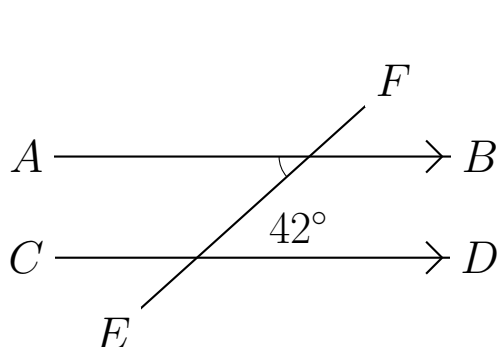

Interior Alternate Angles (F) Answers

Find the alternate angle measurements for the measured angles.

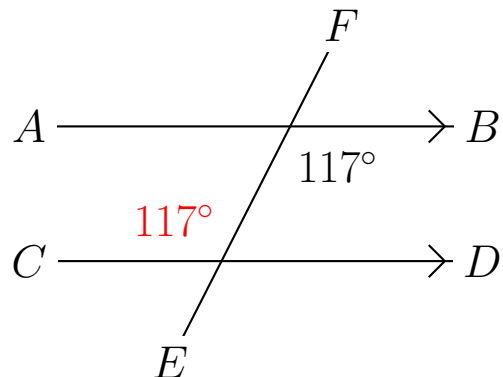
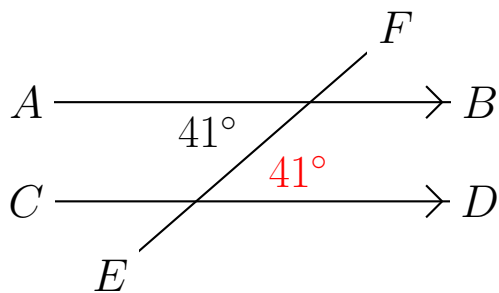
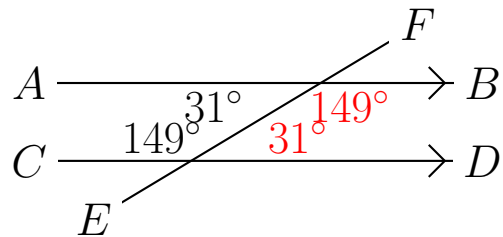
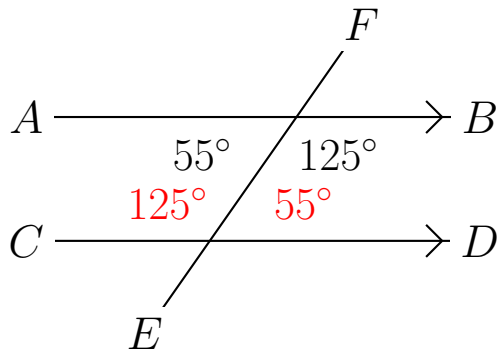
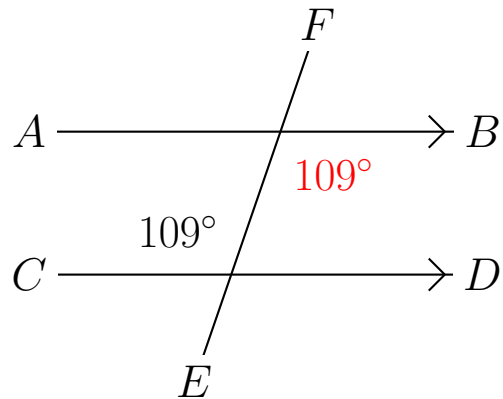
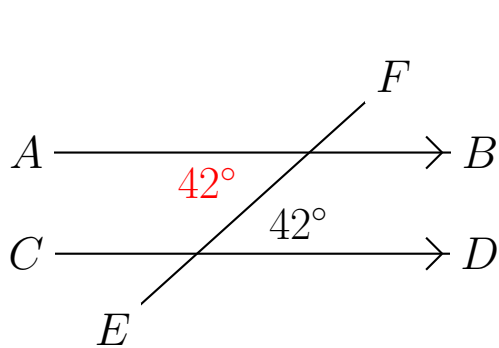

Interior Alternate Angles (G)

Find the alternate angle measurements for the measured angles.

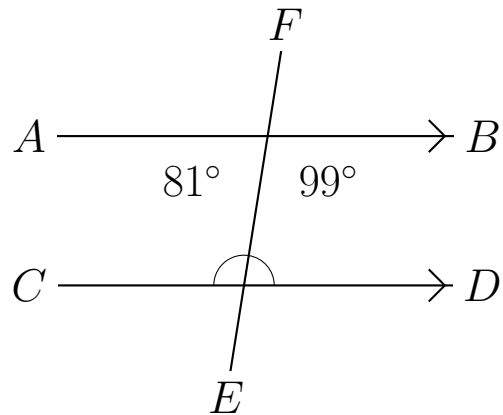
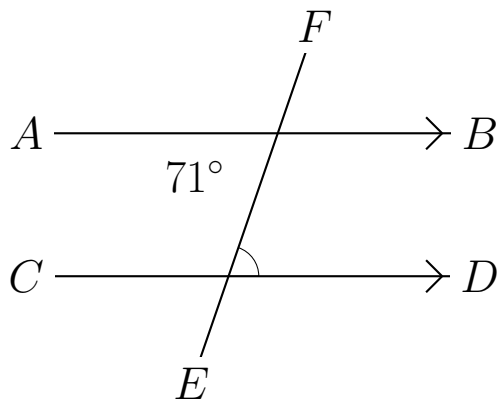
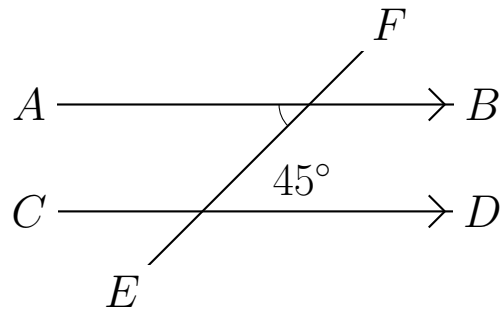
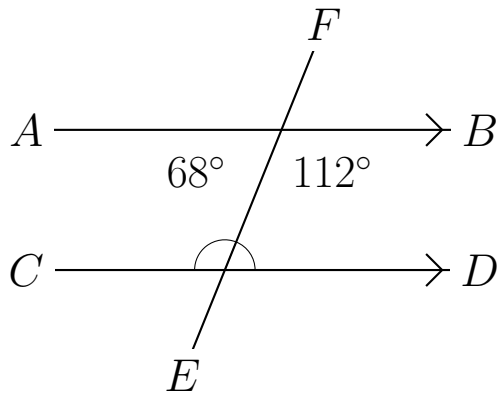
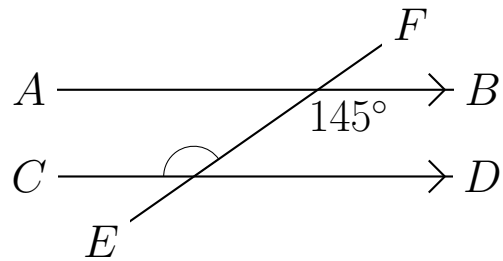
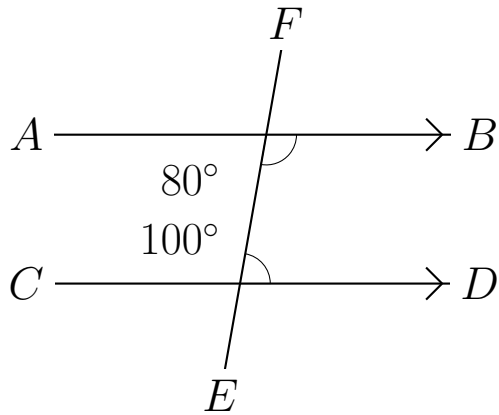

Interior Alternate Angles (G) Answers

Find the alternate angle measurements for the measured angles.

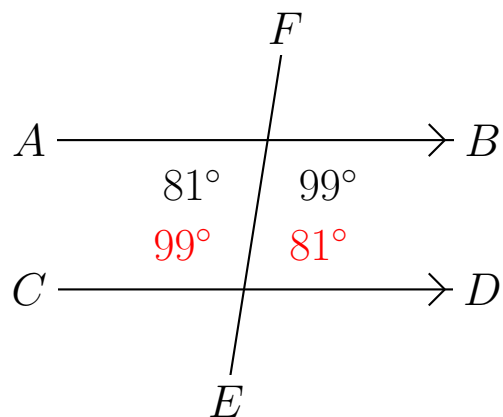
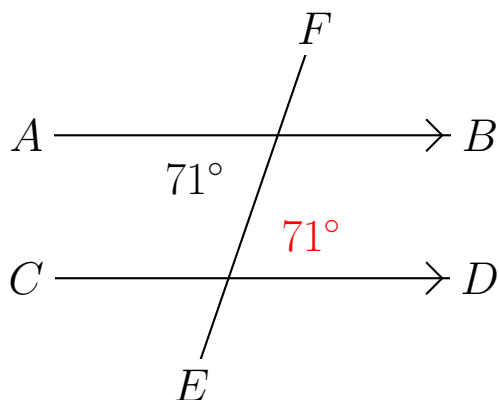
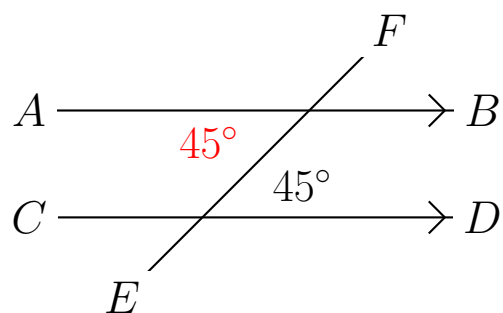
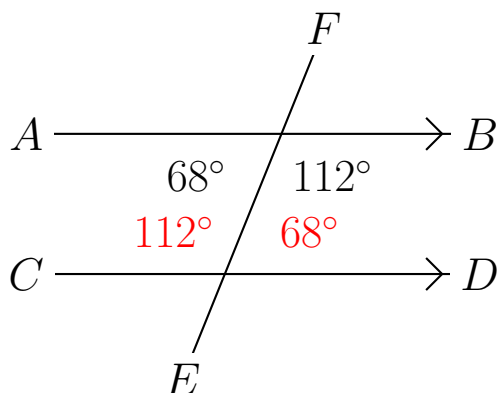
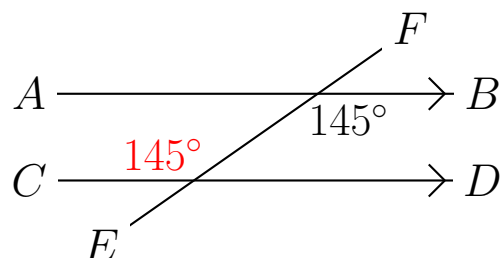
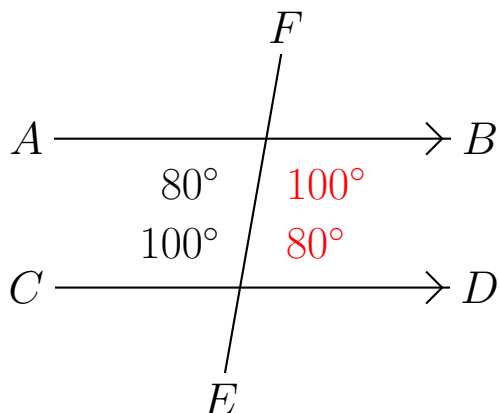

Interior Alternate Angles (H)

Find the alternate angle measurements for the measured angles.

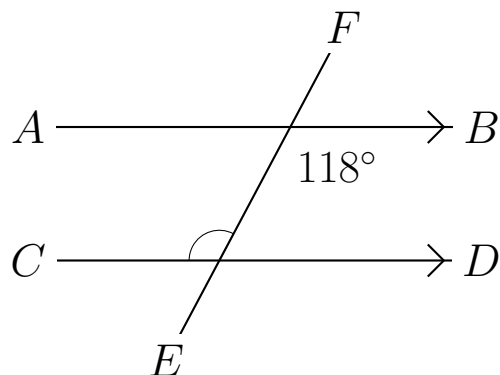
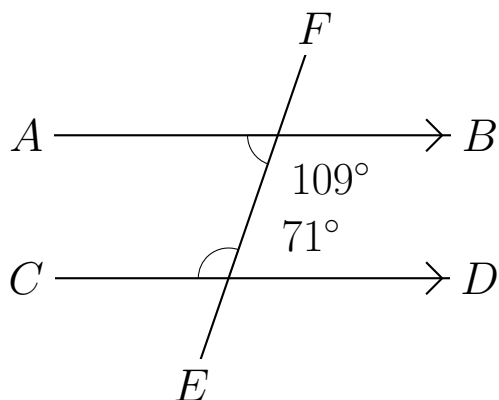
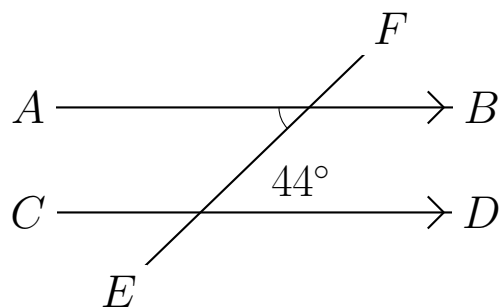
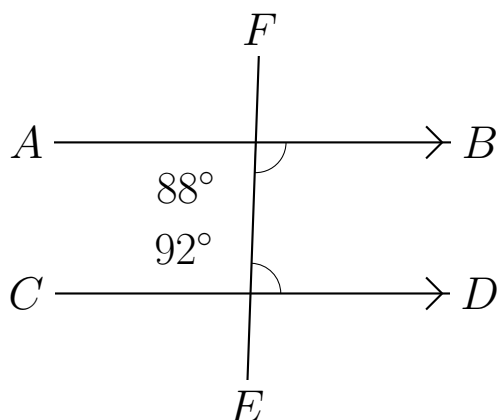
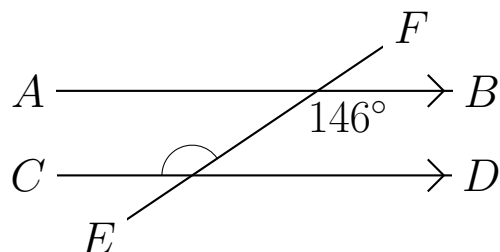
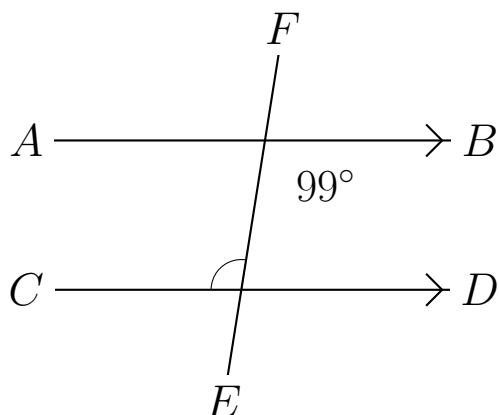

Interior Alternate Angles (H) Answers

Find the alternate angle measurements for the measured angles.

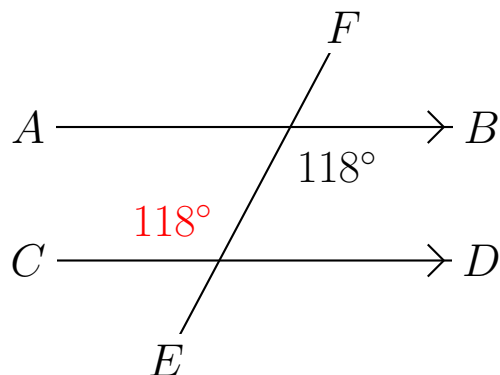
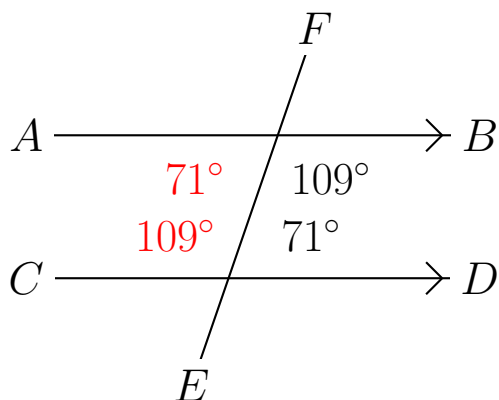
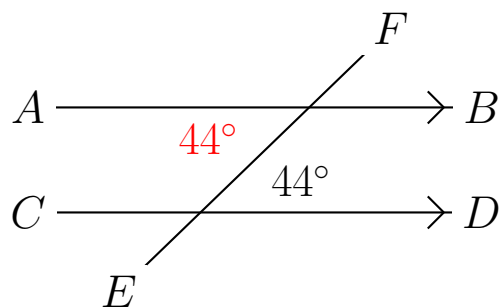
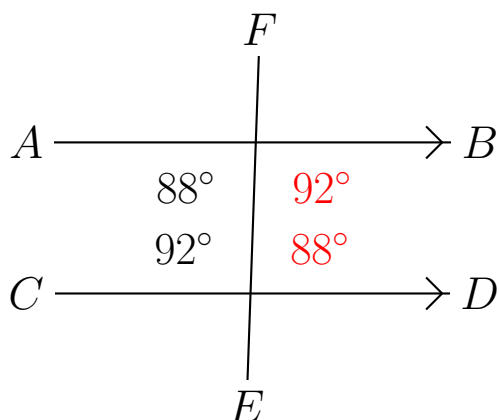
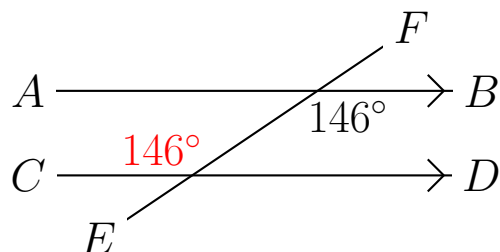
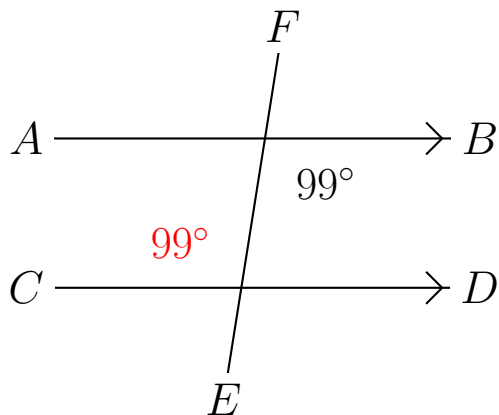

Interior Alternate Angles (I)

Find the alternate angle measurements for the measured angles.

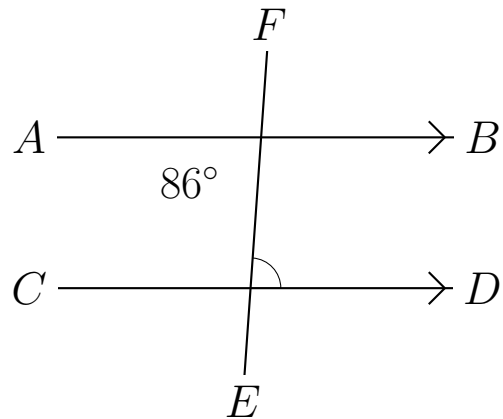
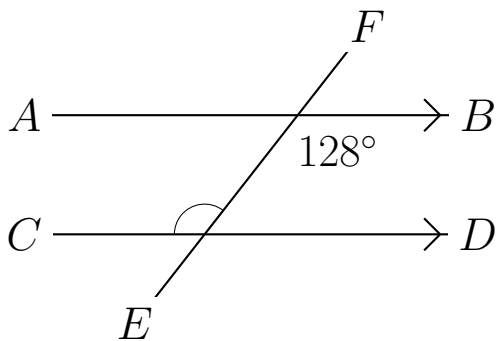
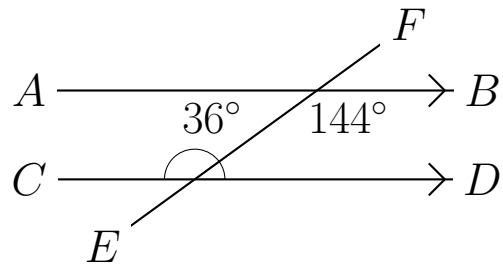
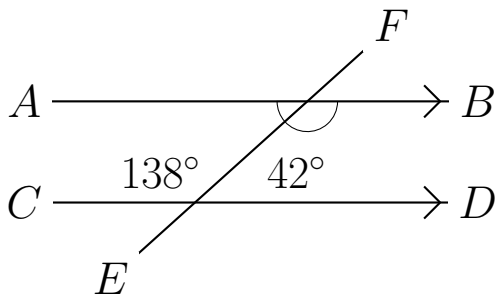
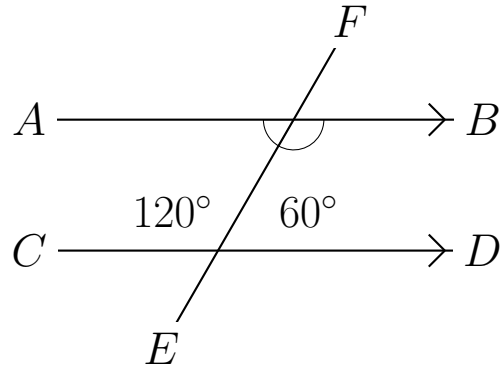
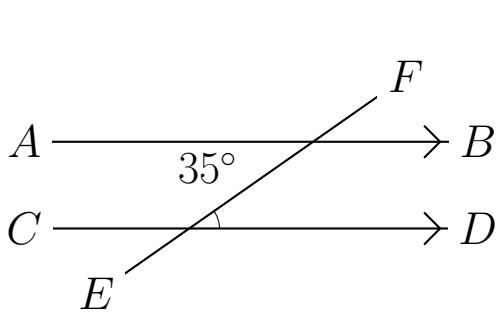

Interior Alternate Angles (I) Answers

Find the alternate angle measurements for the measured angles.

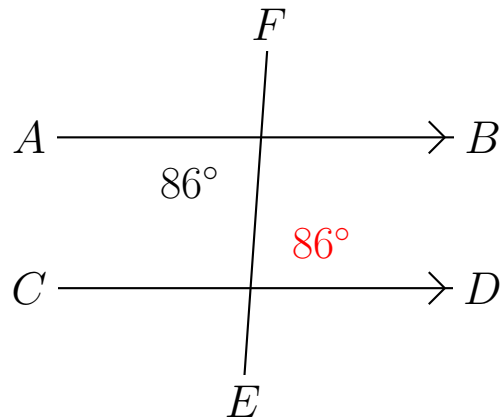
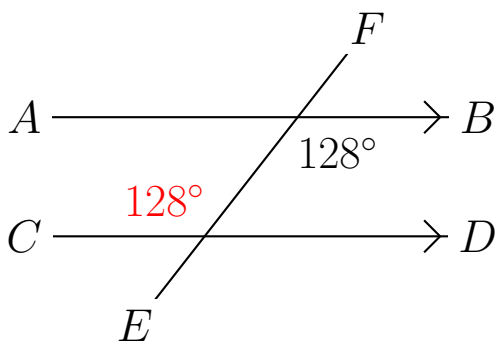
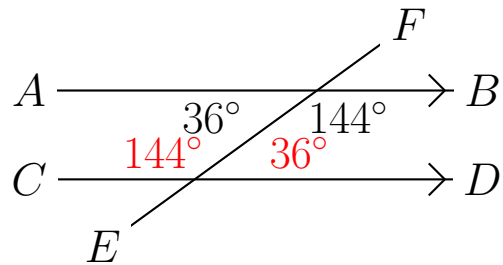
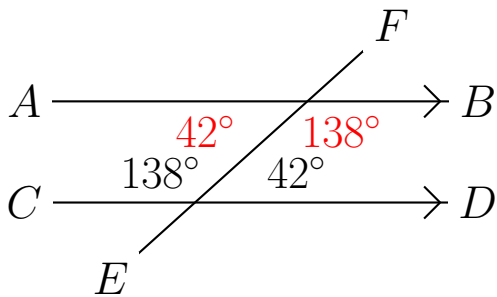
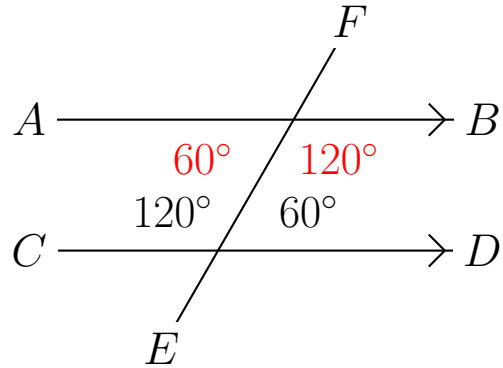
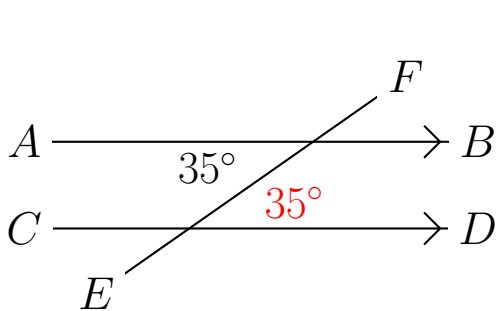

Interior Alternate Angles (J)

Find the alternate angle measurements for the measured angles.

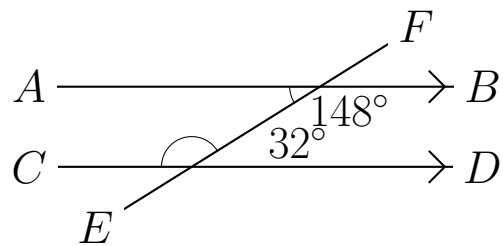
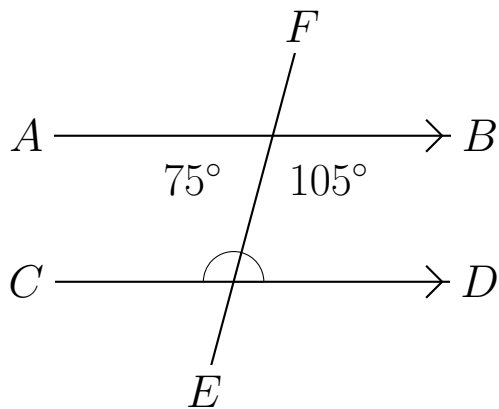
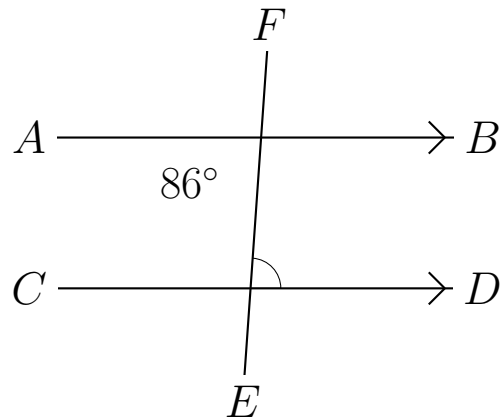
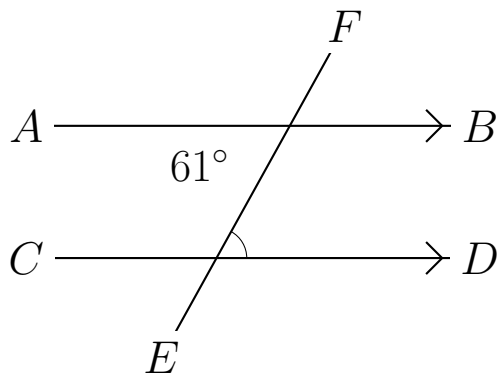
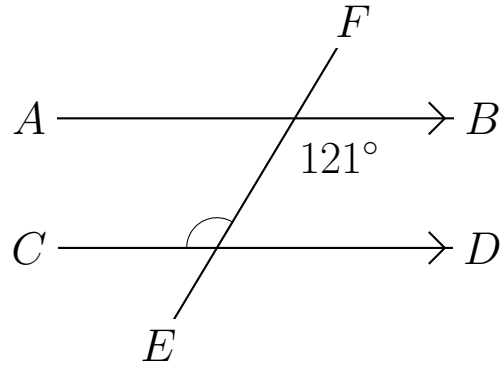
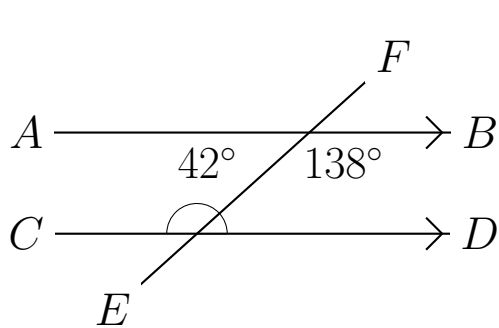

Interior Alternate Angles (J) Answers

Find the alternate angle measurements for the measured angles.

