

Rotations (A)

Draw the intermediate and rotated images.

Rotate 90° clockwise about $(4, 4)$.

Rotate 90° clockwise about $(-4, 3)$.

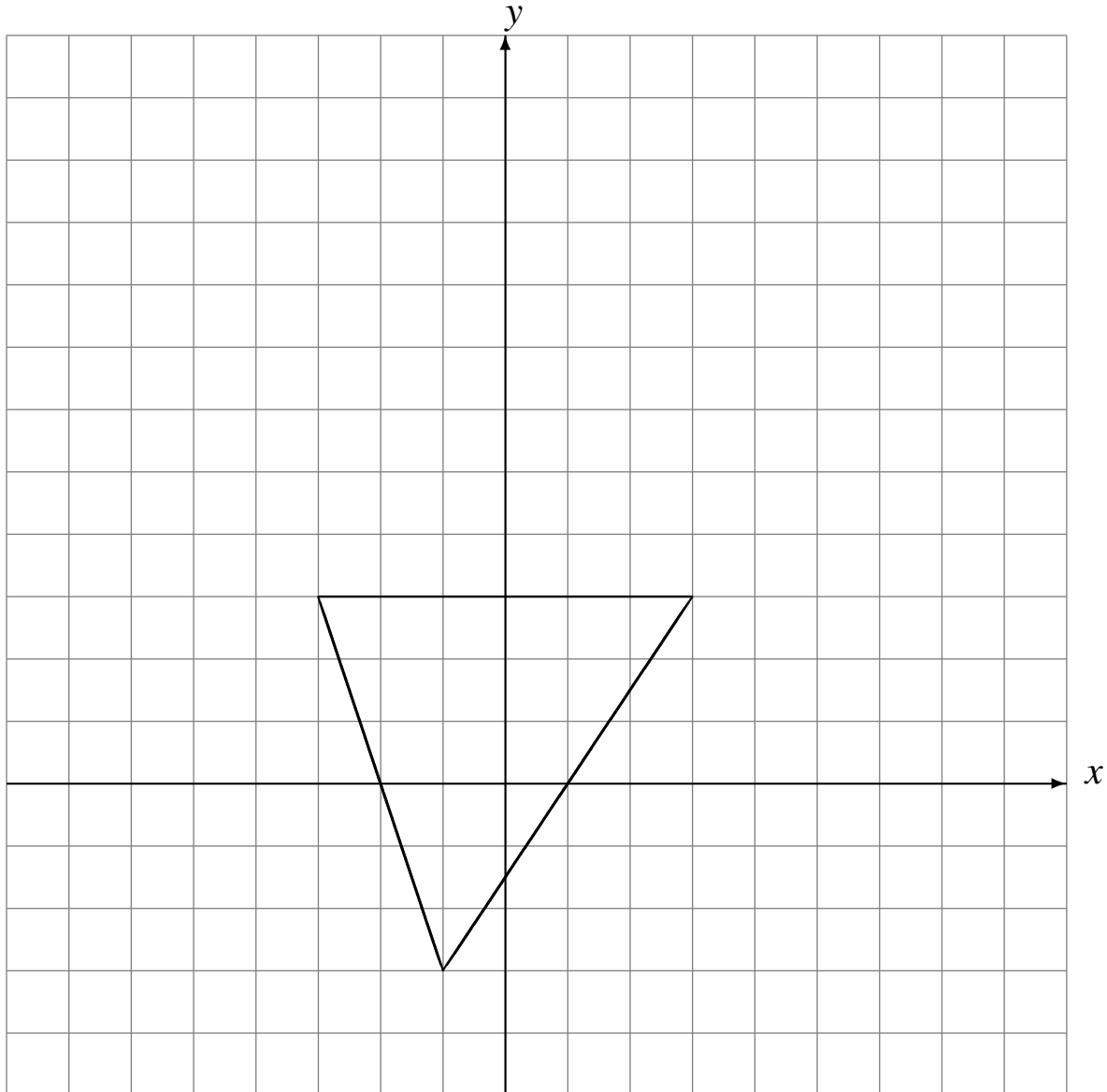

Rotations (A) Answers

Draw the intermediate and rotated images.

Rotate 90° clockwise about $(4, 4)$.

Rotate 90° clockwise about $(-4, 3)$.

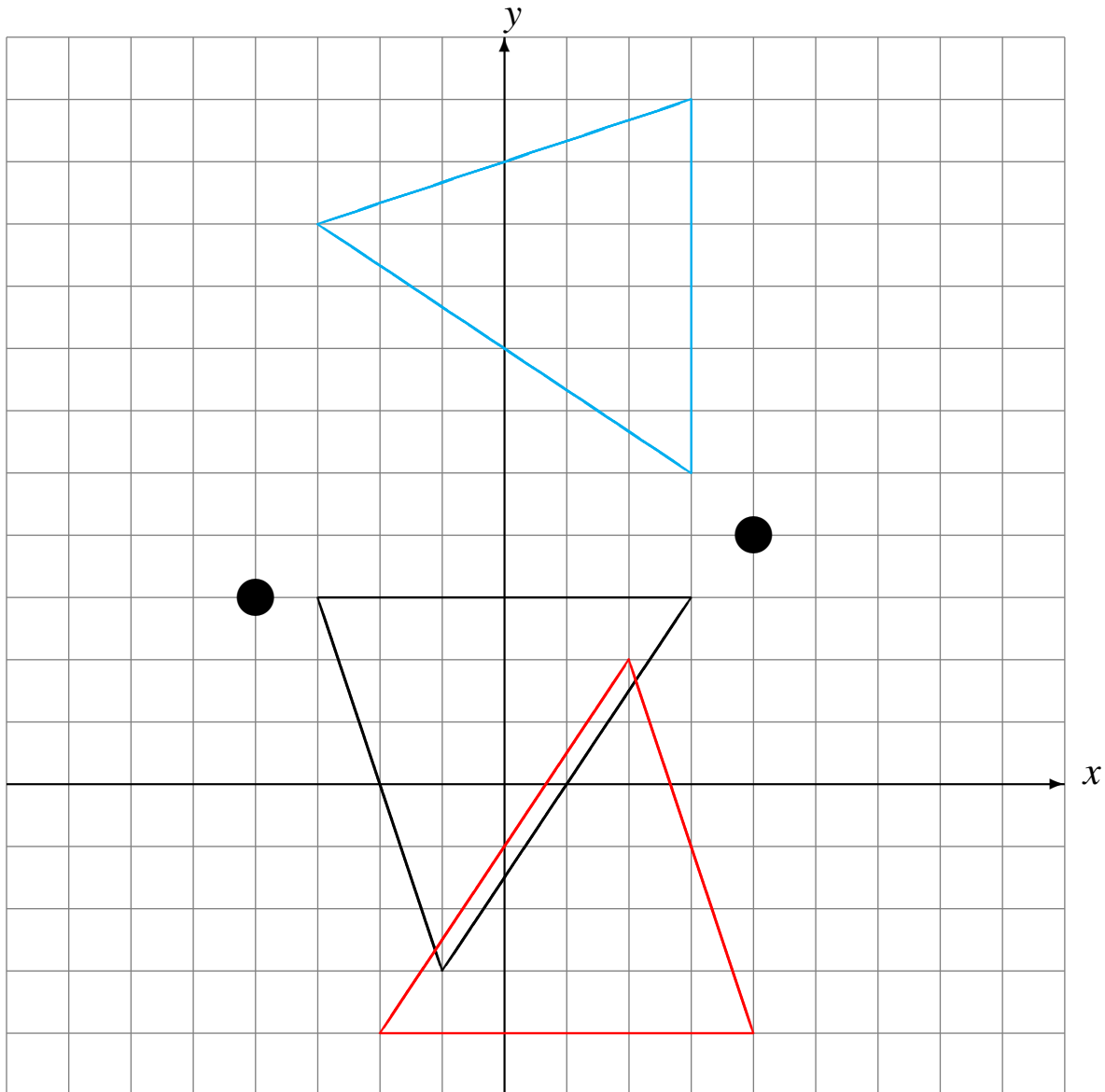

Rotations (B)

Draw the intermediate and rotated images.

Rotate 90° counterclockwise about $(-1, 3)$.

Rotate 180° about $(-1, -4)$.

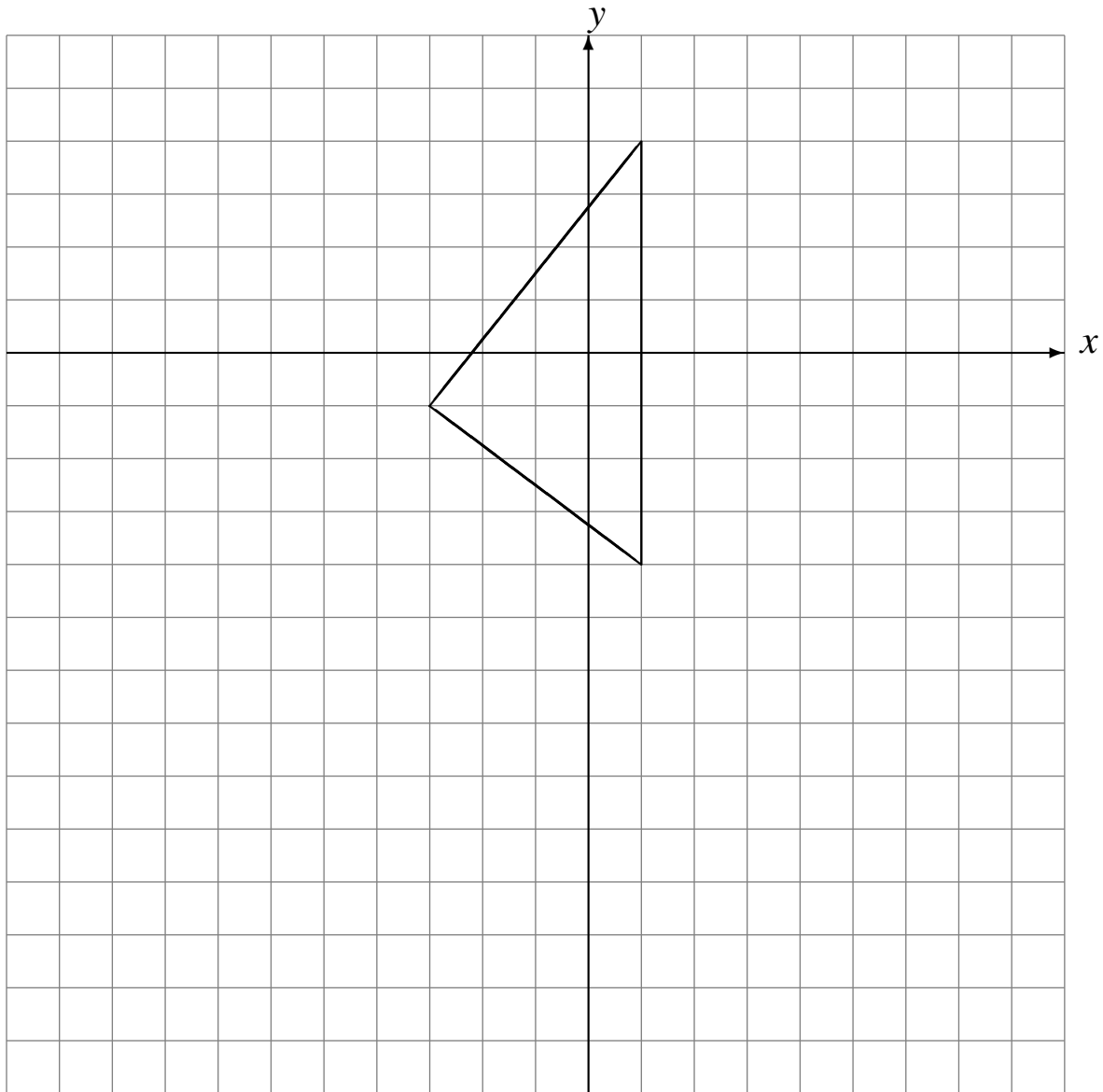

Rotations (B) Answers

Draw the intermediate and rotated images.

Rotate 90° counterclockwise about $(-1, 3)$.

Rotate 180° about $(-1, -4)$.

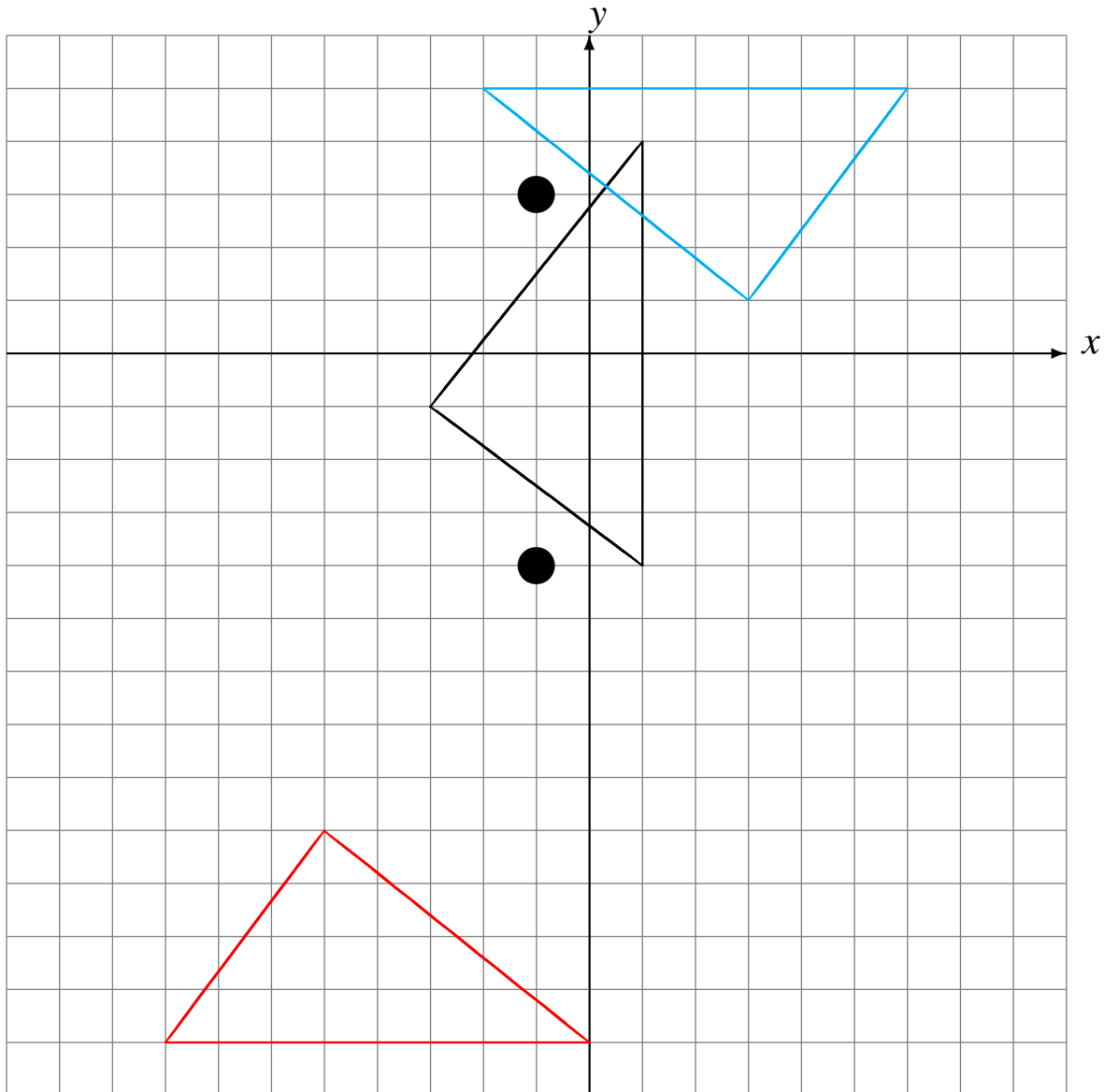

Rotations (C)

Draw the intermediate and rotated images.

Rotate 90° counterclockwise about $(-1, -4)$.

Rotate 90° clockwise about $(0, -5)$.

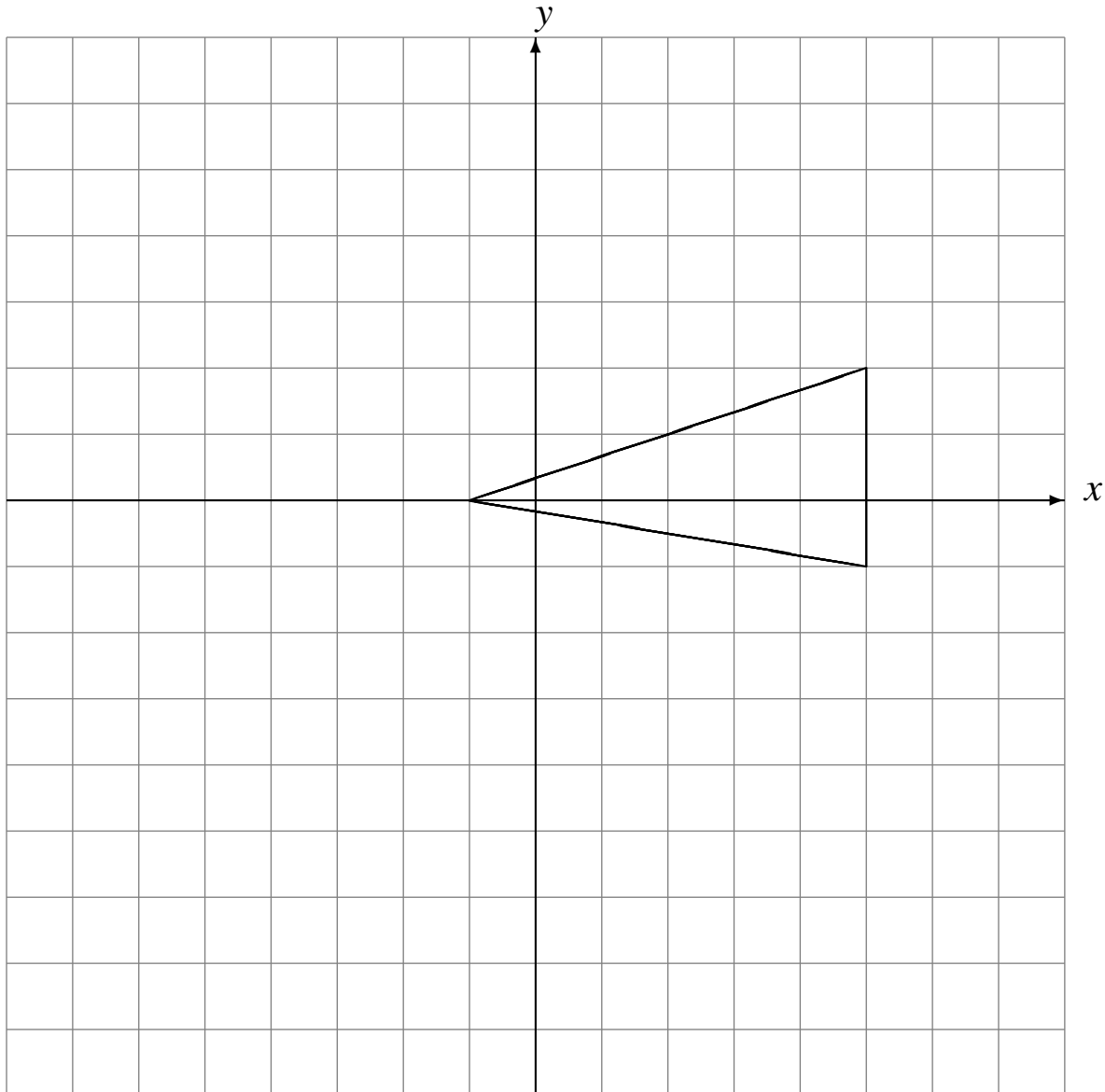

Rotations (C) Answers

Draw the intermediate and rotated images.

Rotate 90° counterclockwise about $(-1, -4)$.

Rotate 90° clockwise about $(0, -5)$.

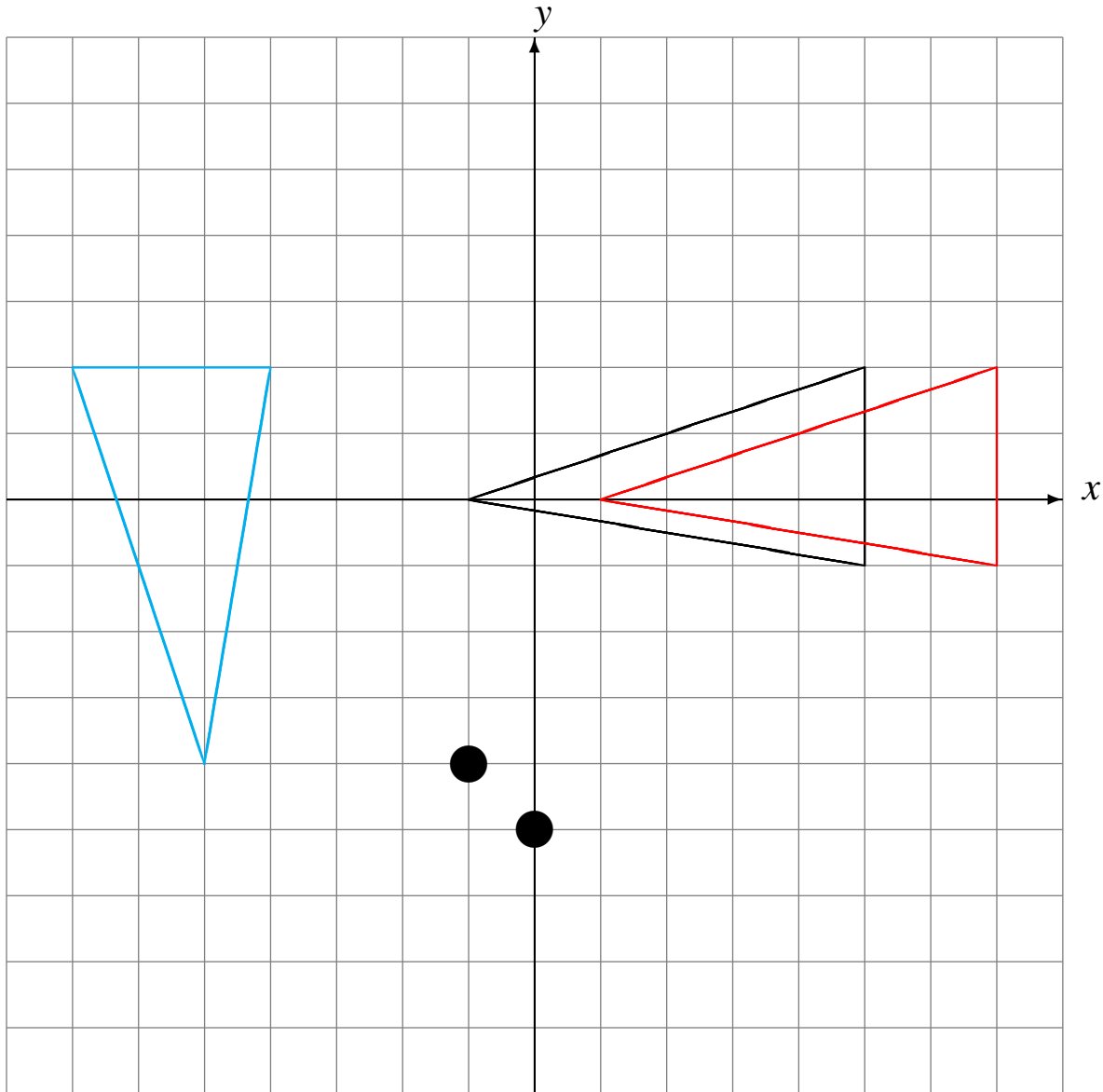

Rotations (D)

Draw the intermediate and rotated images.

Rotate 90° clockwise about $(-1, 2)$.

Rotate 180° about $(-2, 0)$.

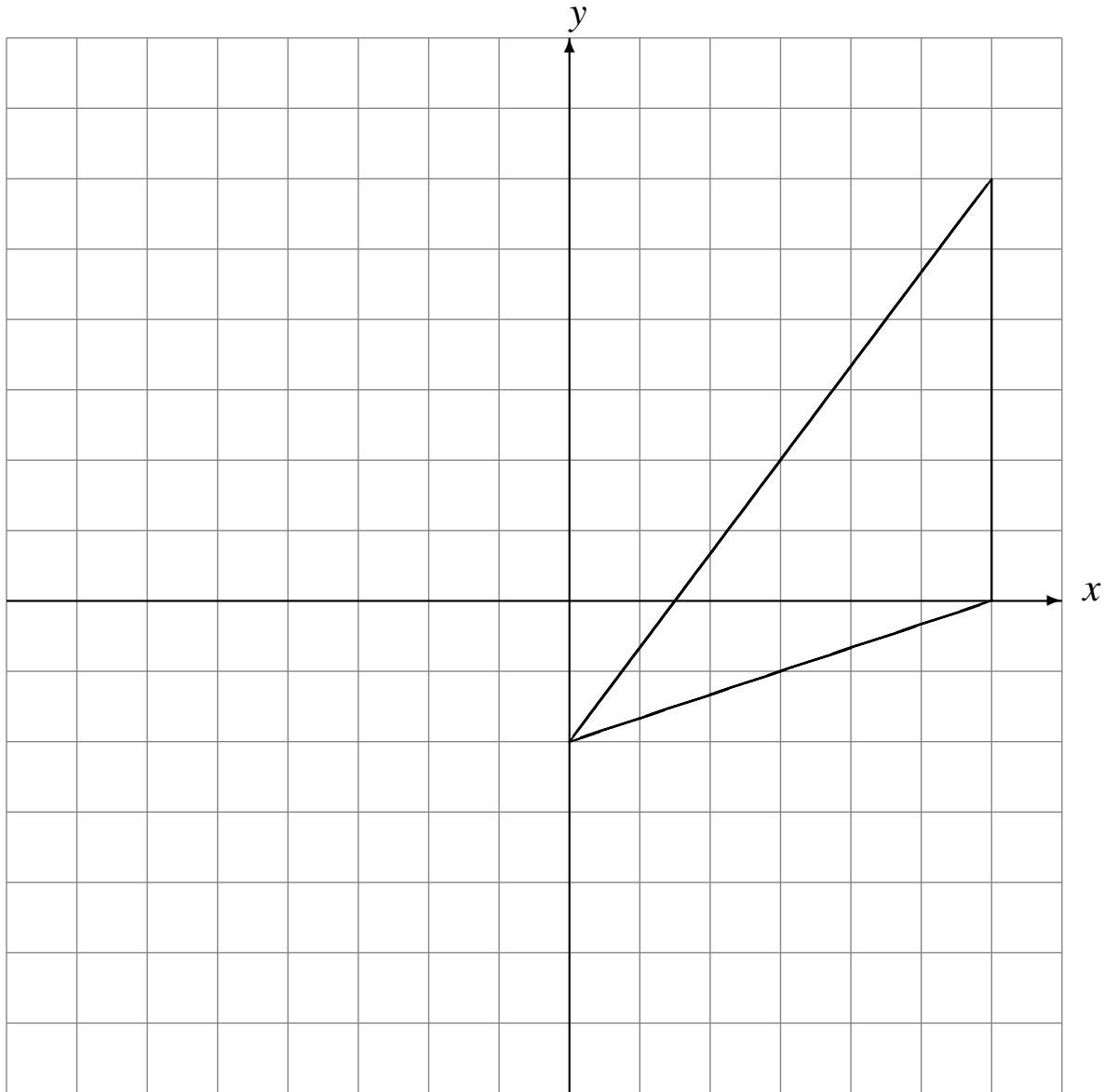

Rotations (D) Answers

Draw the intermediate and rotated images.

Rotate 90° clockwise about $(-1, 2)$.

Rotate 180° about $(-2, 0)$.

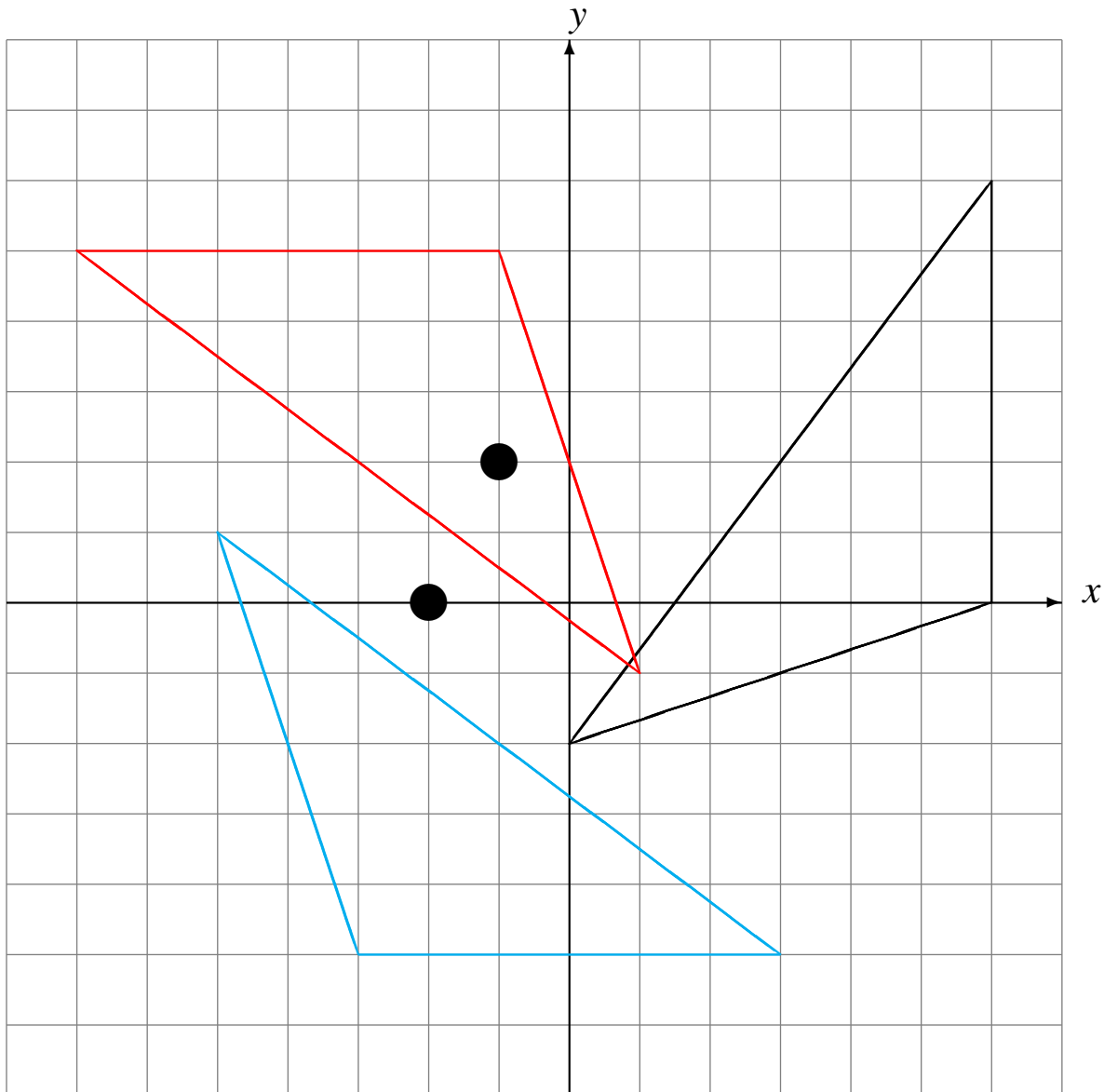

Rotations (E)

Draw the intermediate and rotated images.

Rotate 90° clockwise about $(-1, 5)$.

Rotate 90° clockwise about $(2, 0)$.

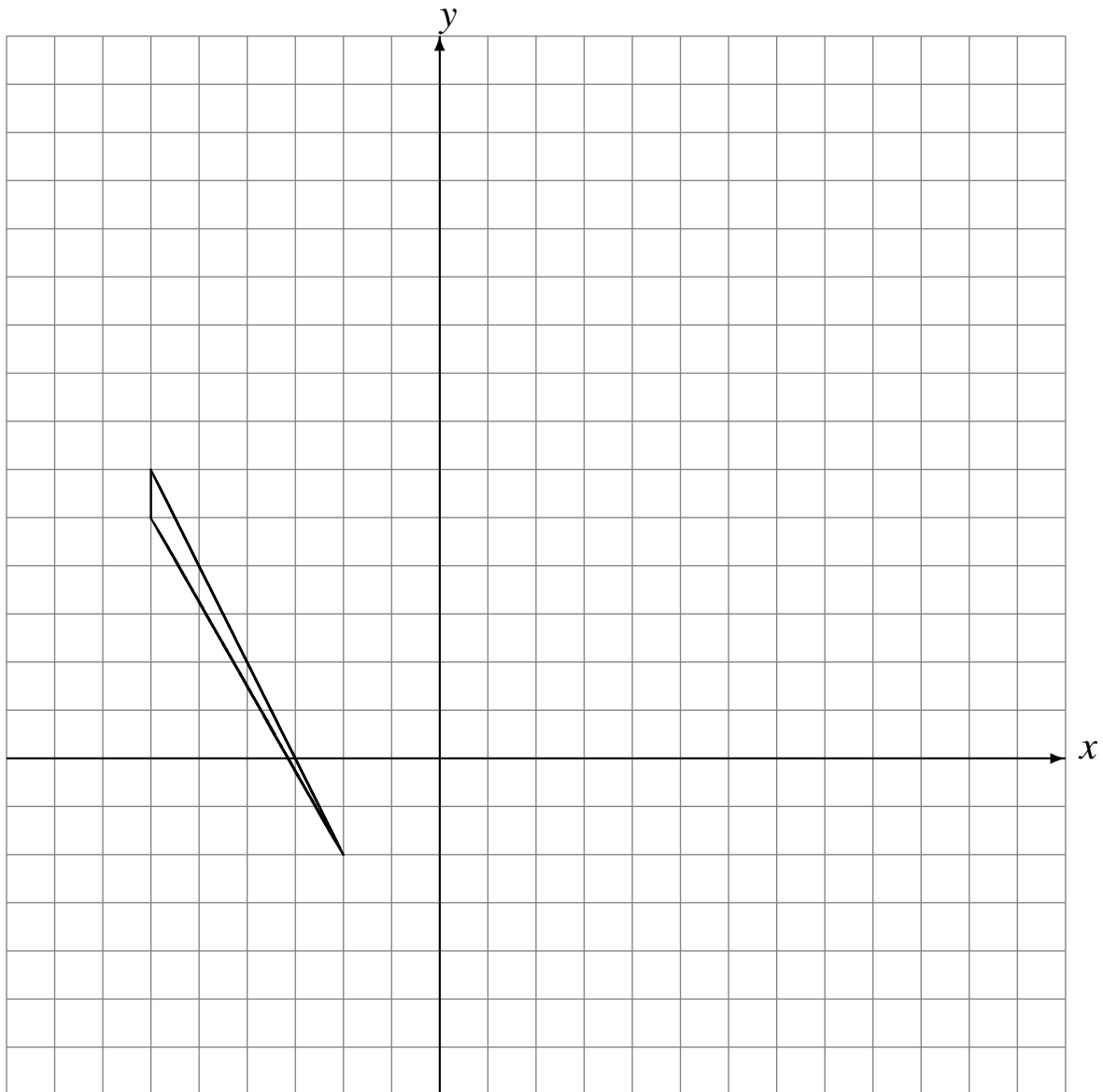

Rotations (E) Answers

Draw the intermediate and rotated images.

Rotate 90° clockwise about $(-1, 5)$.

Rotate 90° clockwise about $(2, 0)$.

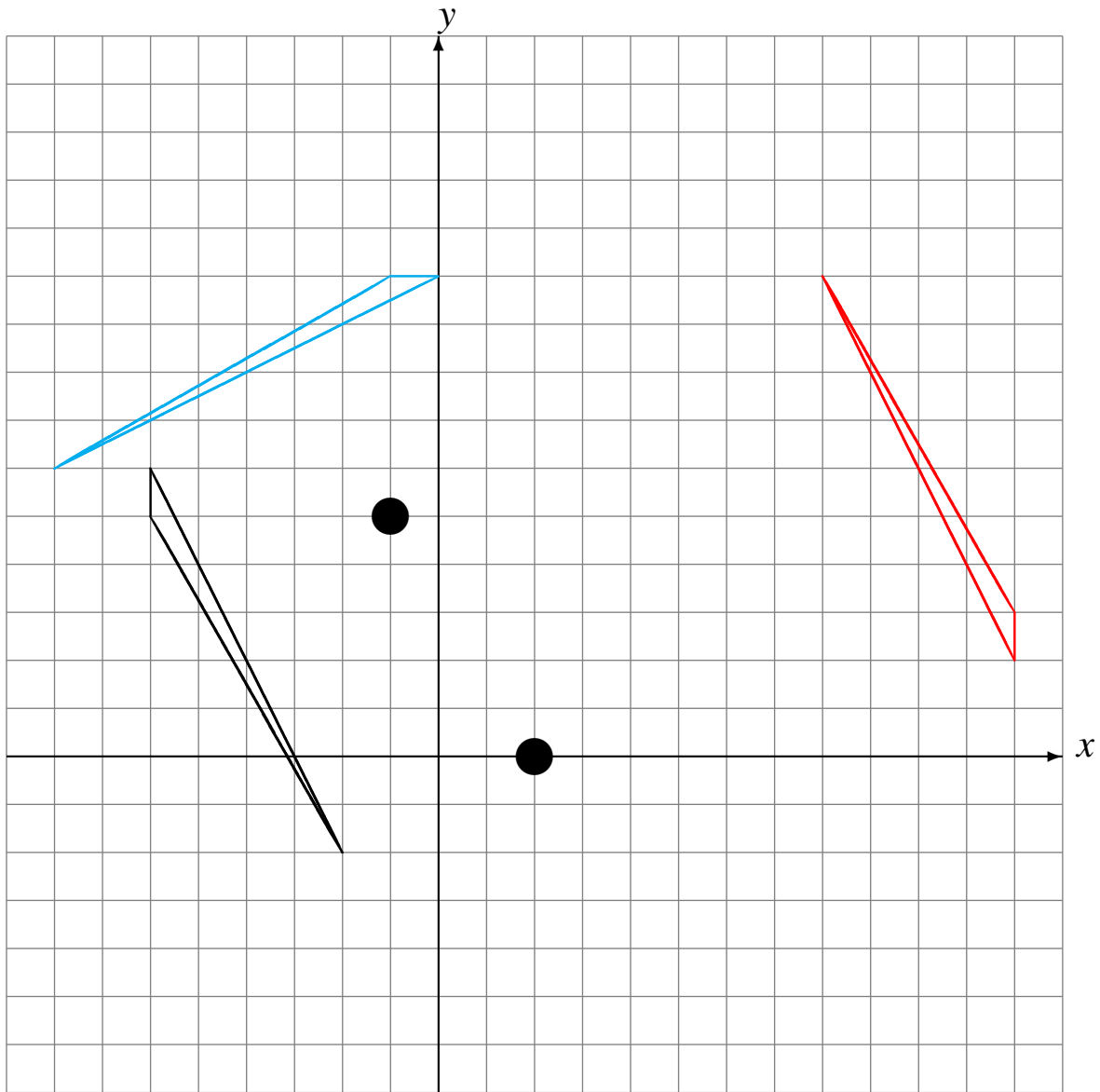

Rotations (F)

Draw the intermediate and rotated images.

Rotate 90° counterclockwise about $(3, 4)$.

Rotate 90° clockwise about $(-1, 0)$.

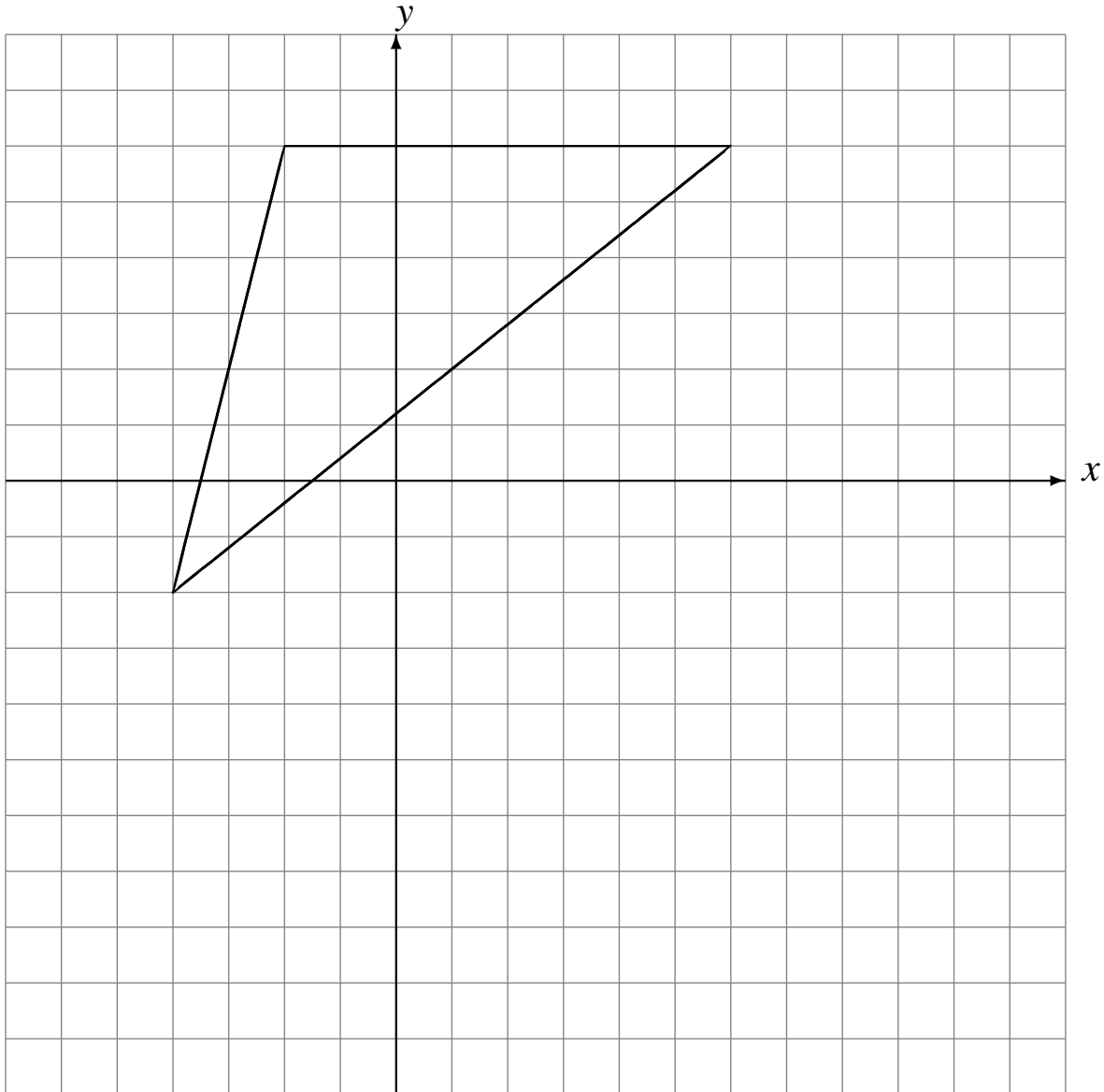

Rotations (F) Answers

Draw the intermediate and rotated images.

Rotate 90° counterclockwise about $(3, 4)$.

Rotate 90° clockwise about $(-1, 0)$.

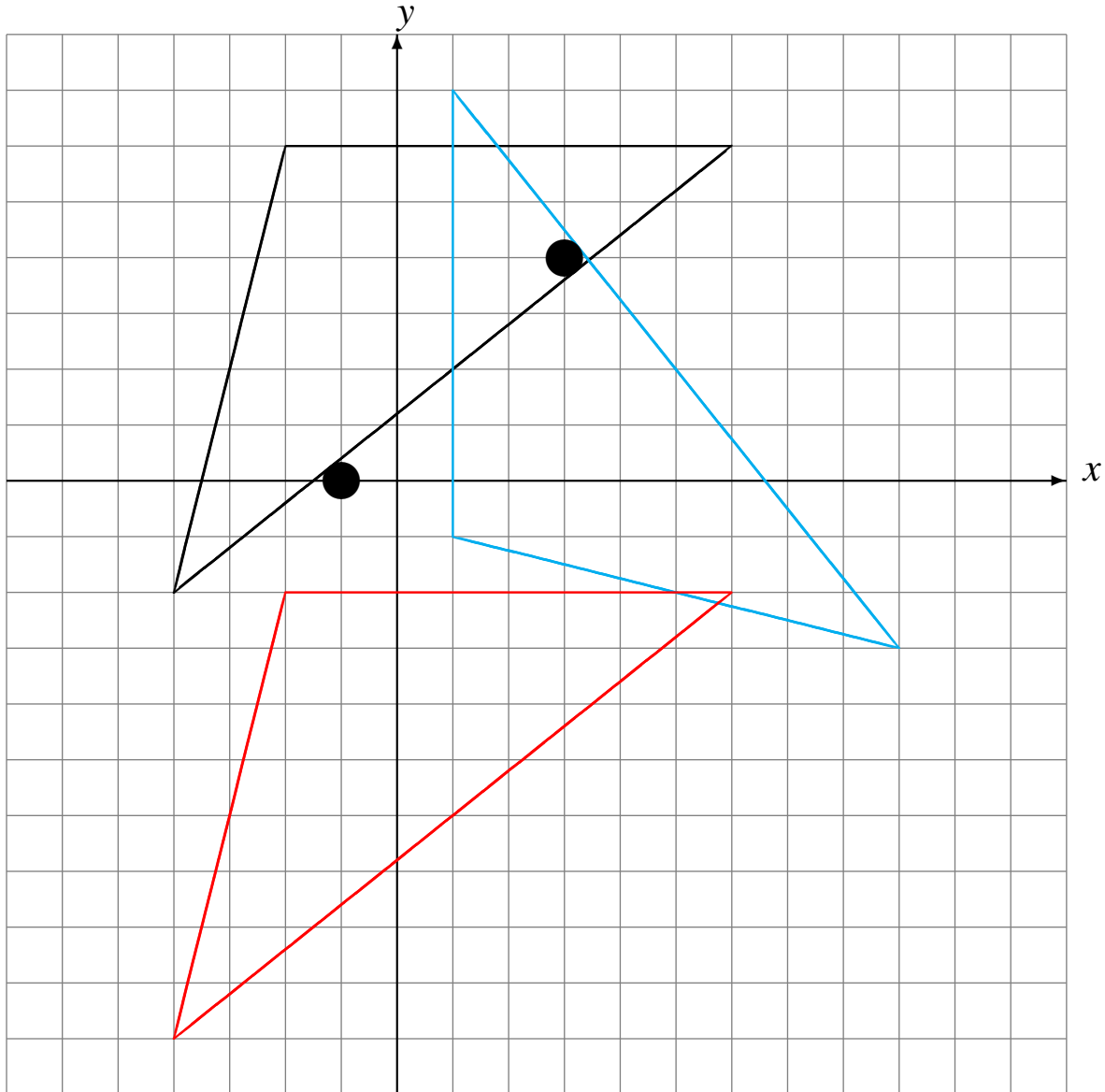

Rotations (G)

Draw the intermediate and rotated images.

Rotate 90° clockwise about $(5, 4)$.

Rotate 180° about $(-1, 0)$.

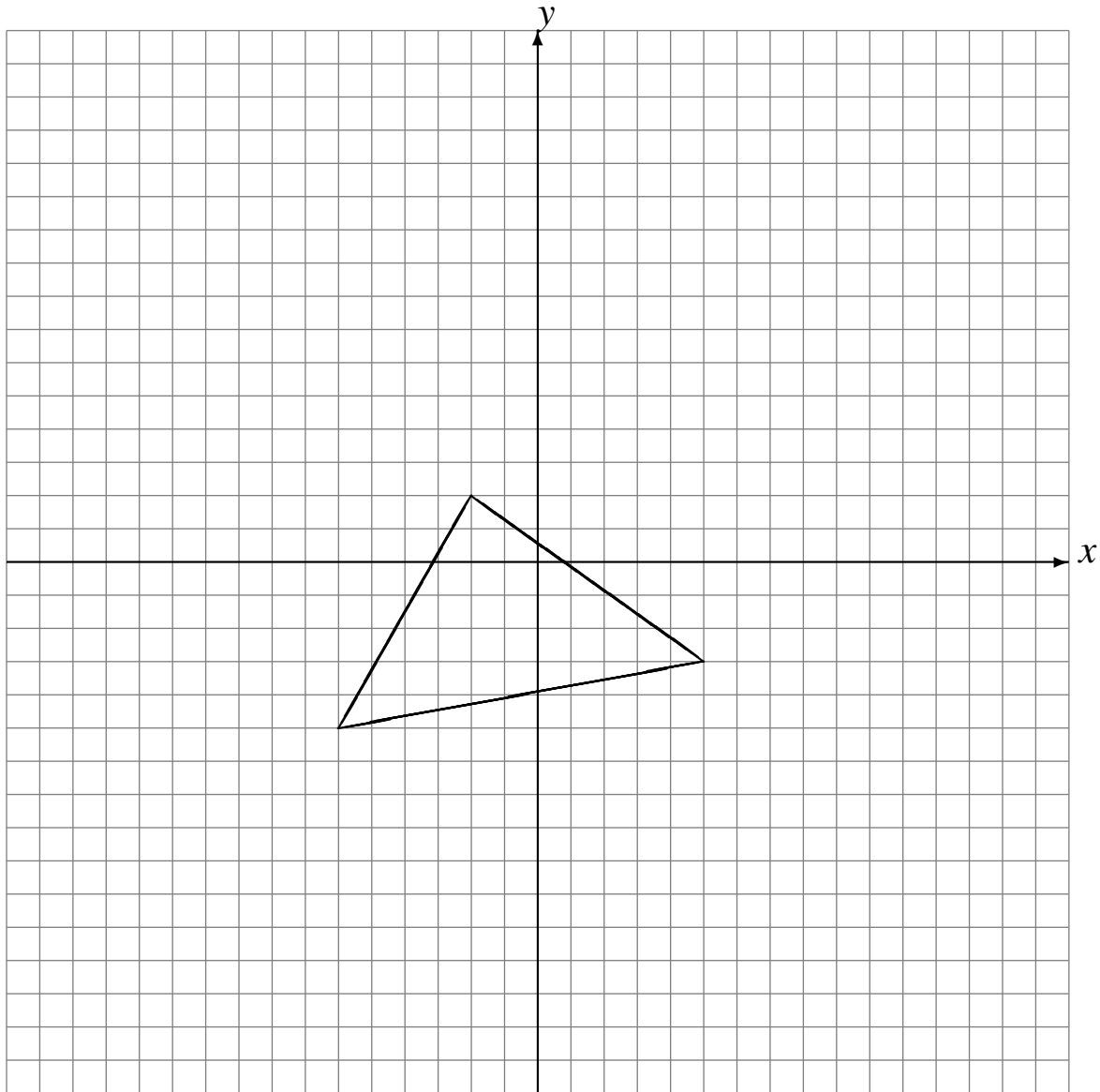

Rotations (G) Answers

Draw the intermediate and rotated images.

Rotate 90° clockwise about $(5, 4)$.

Rotate 180° about $(-1, 0)$.

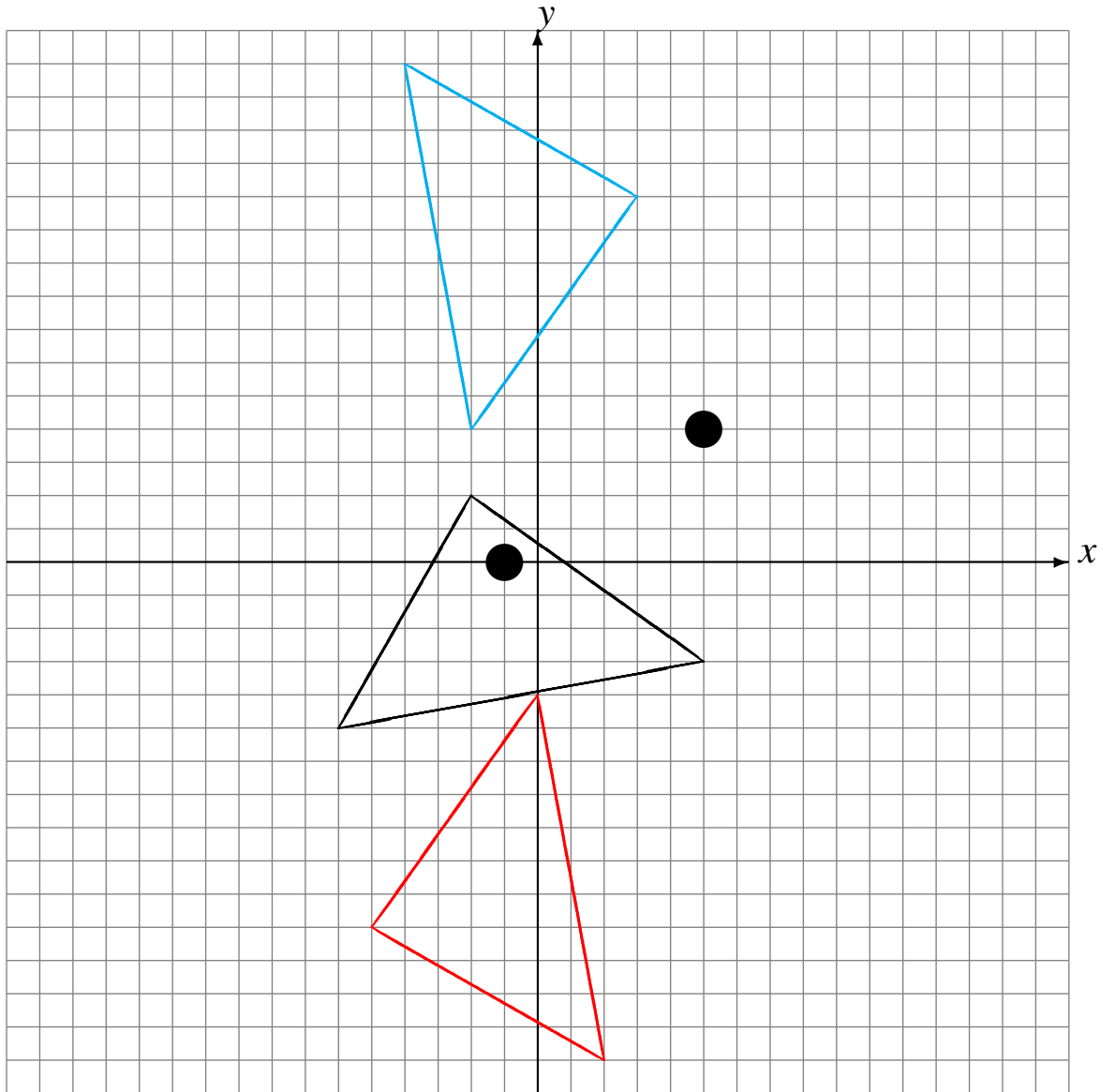

Rotations (H)

Draw the intermediate and rotated images.

Rotate 90° clockwise about $(4, 5)$.

Rotate 90° counterclockwise about $(-2, -5)$.

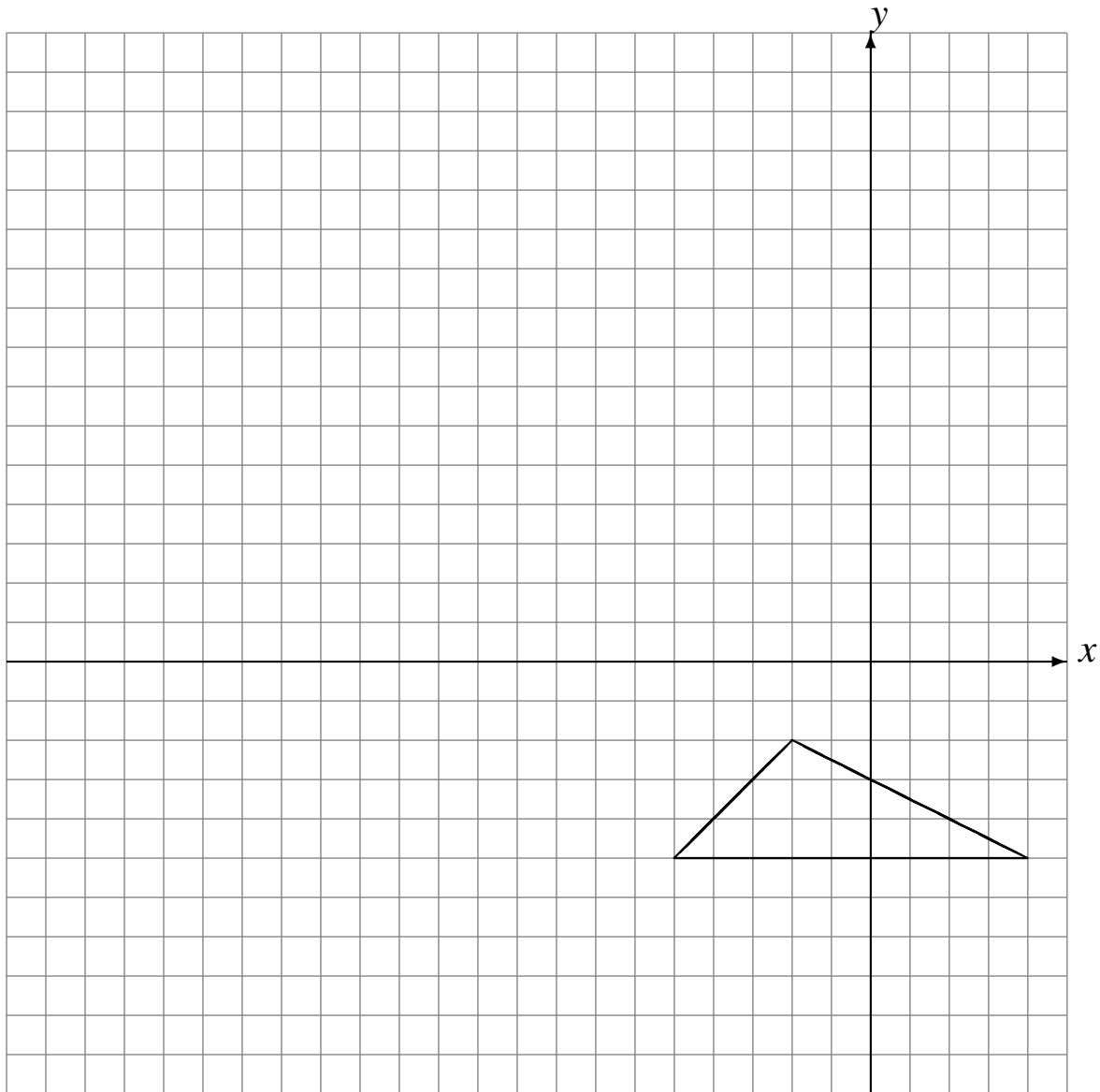

Rotations (H) Answers

Draw the intermediate and rotated images.

Rotate 90° clockwise about $(4, 5)$.

Rotate 90° counterclockwise about $(-2, -5)$.

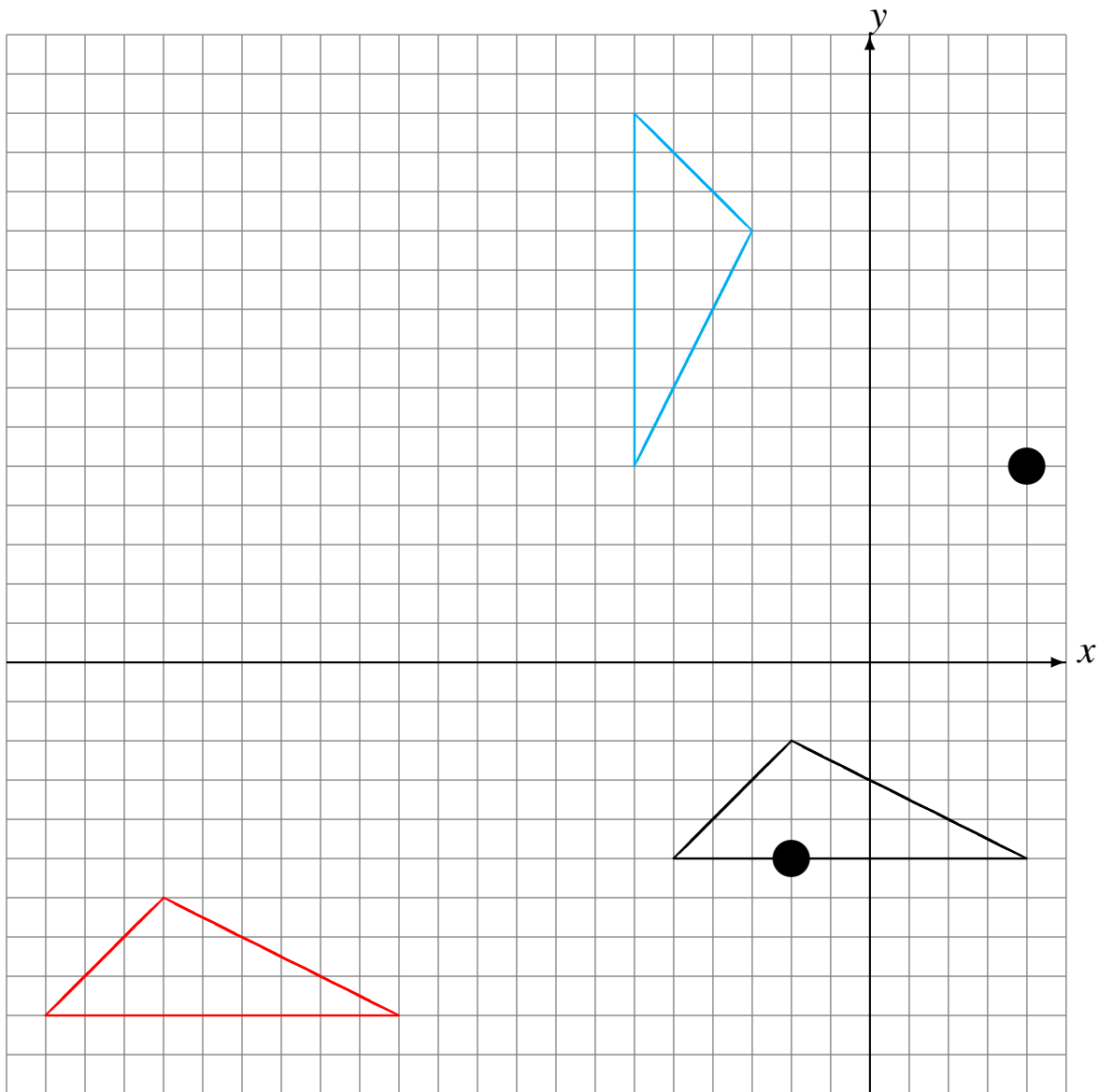

Rotations (I)

Draw the intermediate and rotated images.

Rotate 90° clockwise about $(1, -5)$.

Rotate 180° about $(2, -5)$.

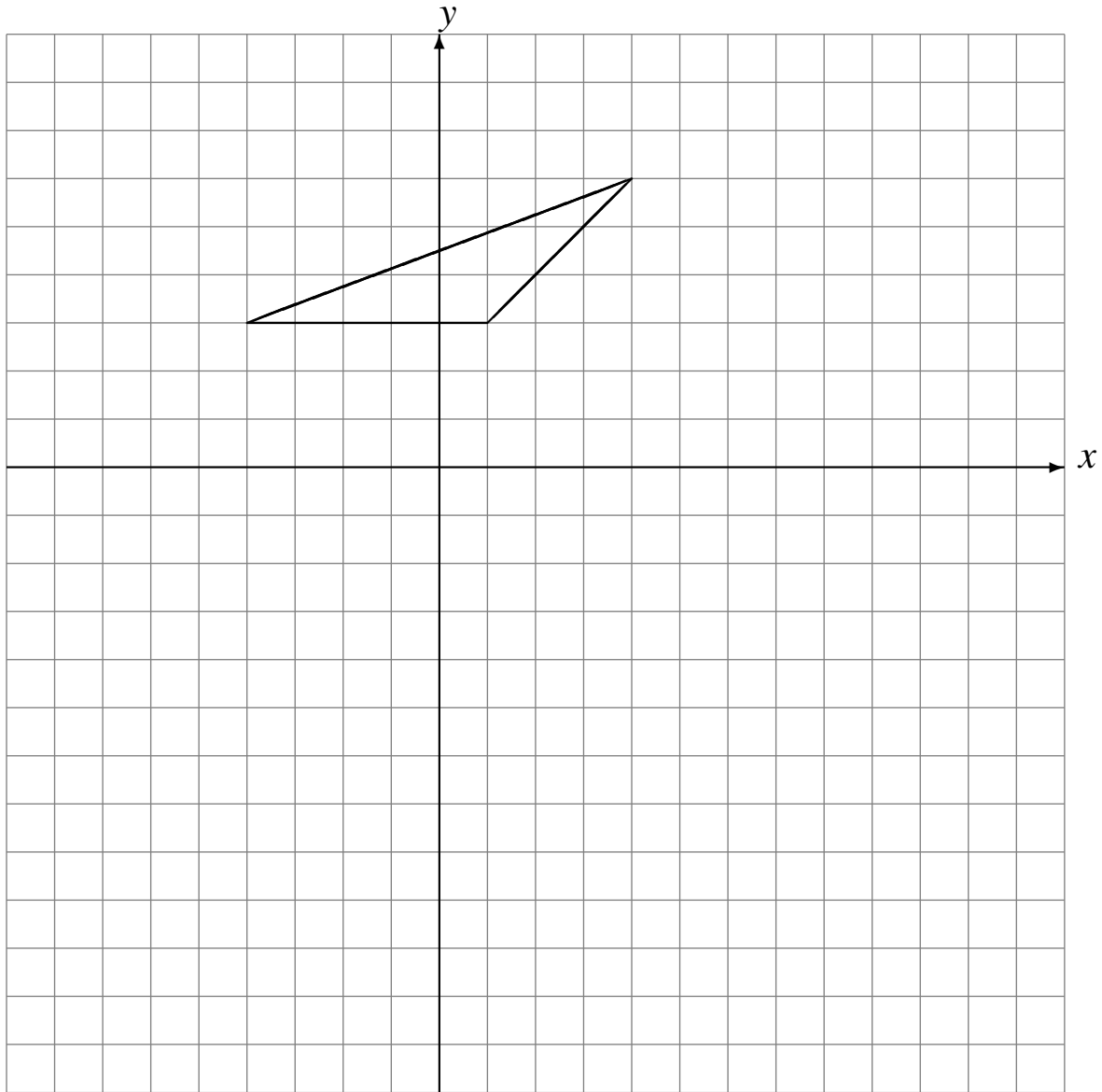

Rotations (I) Answers

Draw the intermediate and rotated images.

Rotate 90° clockwise about $(1, -5)$.

Rotate 180° about $(2, -5)$.

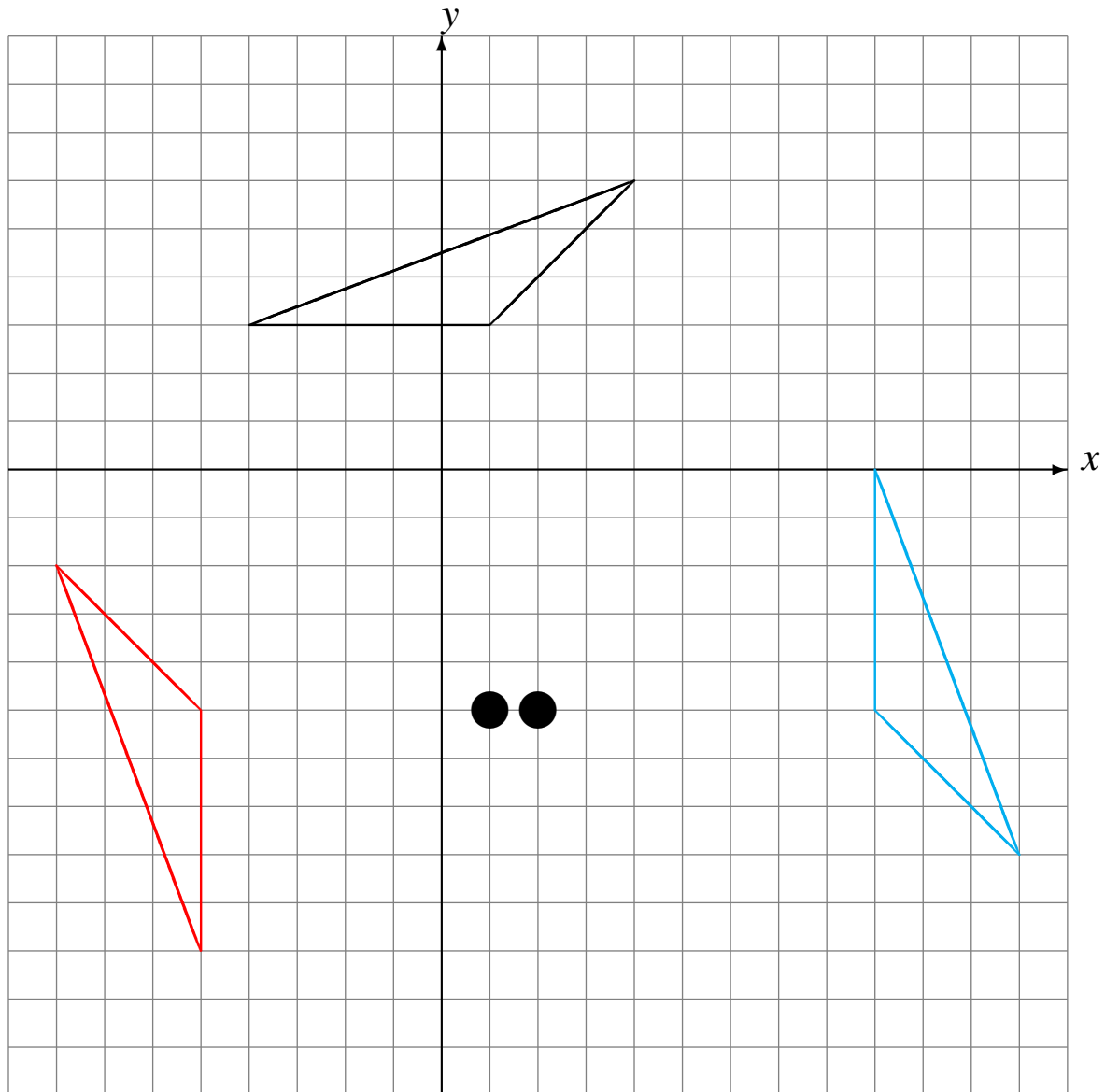

Rotations (J)

Draw the intermediate and rotated images.

Rotate 90° clockwise about $(0, 3)$.

Rotate 180° about $(4, -2)$.

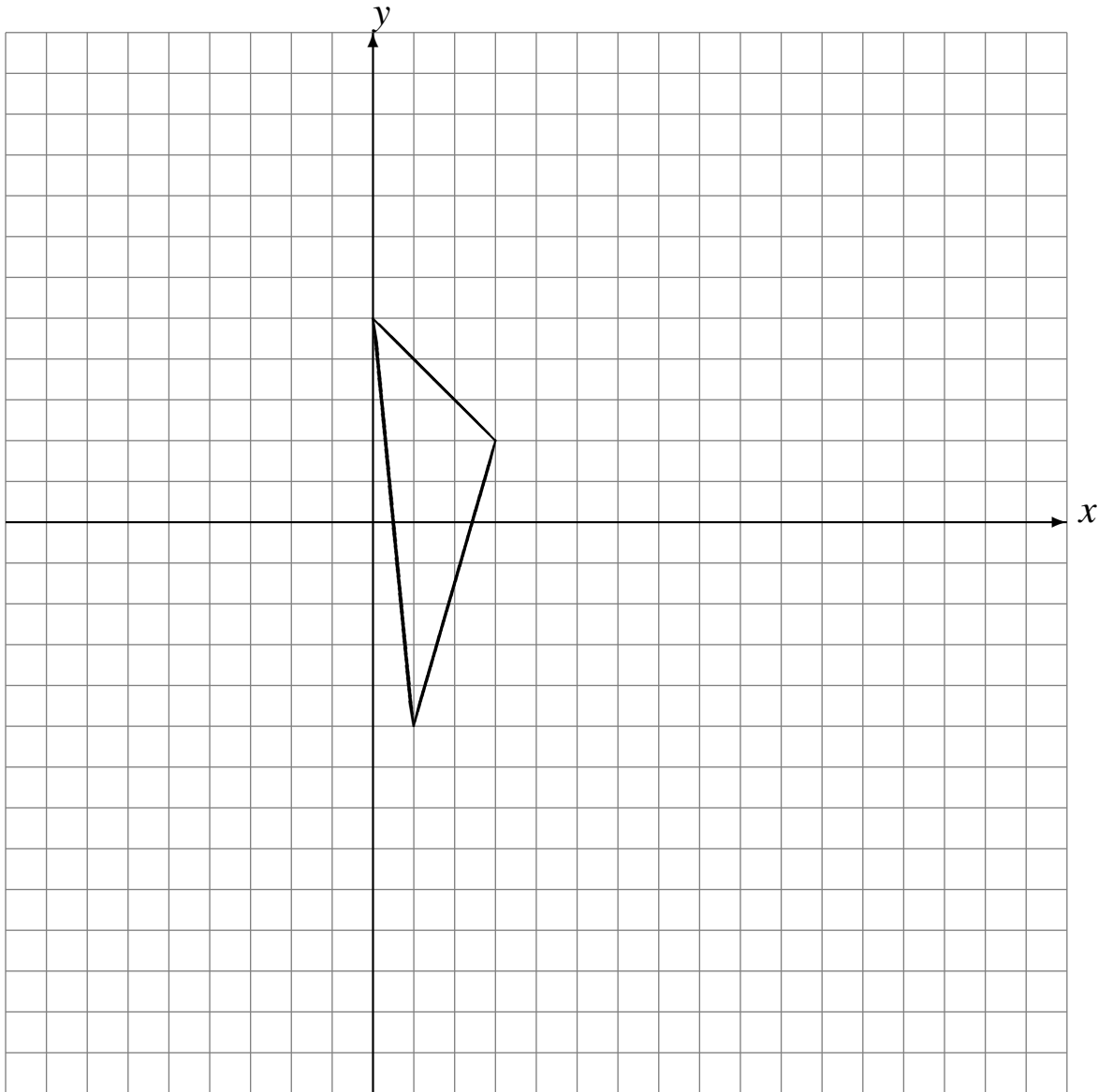

Rotations (J) Answers

Draw the intermediate and rotated images.

Rotate 90° clockwise about $(0, 3)$.

Rotate 180° about $(4, -2)$.

