

# Rotations (A)

Draw the intermediate and rotated images.

- Rotate  $90^\circ$  clockwise about  $(-2, 4)$ .
- Rotate  $90^\circ$  clockwise about  $(-4, -1)$ .
- Rotate  $90^\circ$  counterclockwise about  $(-5, 1)$ .

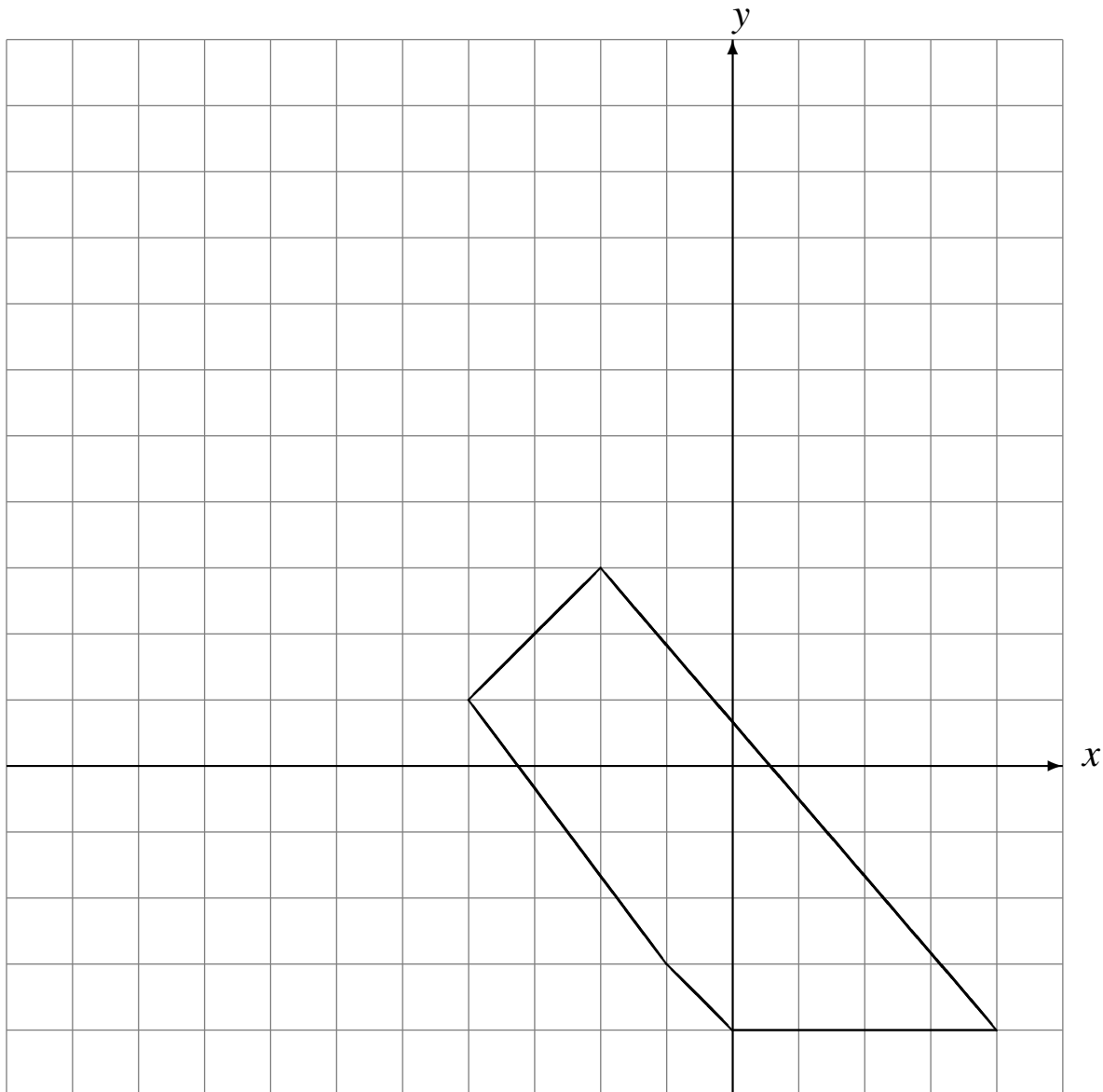

# Rotations (A) Answers

Draw the intermediate and rotated images.

- Rotate  $90^\circ$  clockwise about  $(-2, 4)$ .
- Rotate  $90^\circ$  clockwise about  $(-4, -1)$ .
- Rotate  $90^\circ$  counterclockwise about  $(-5, 1)$ .

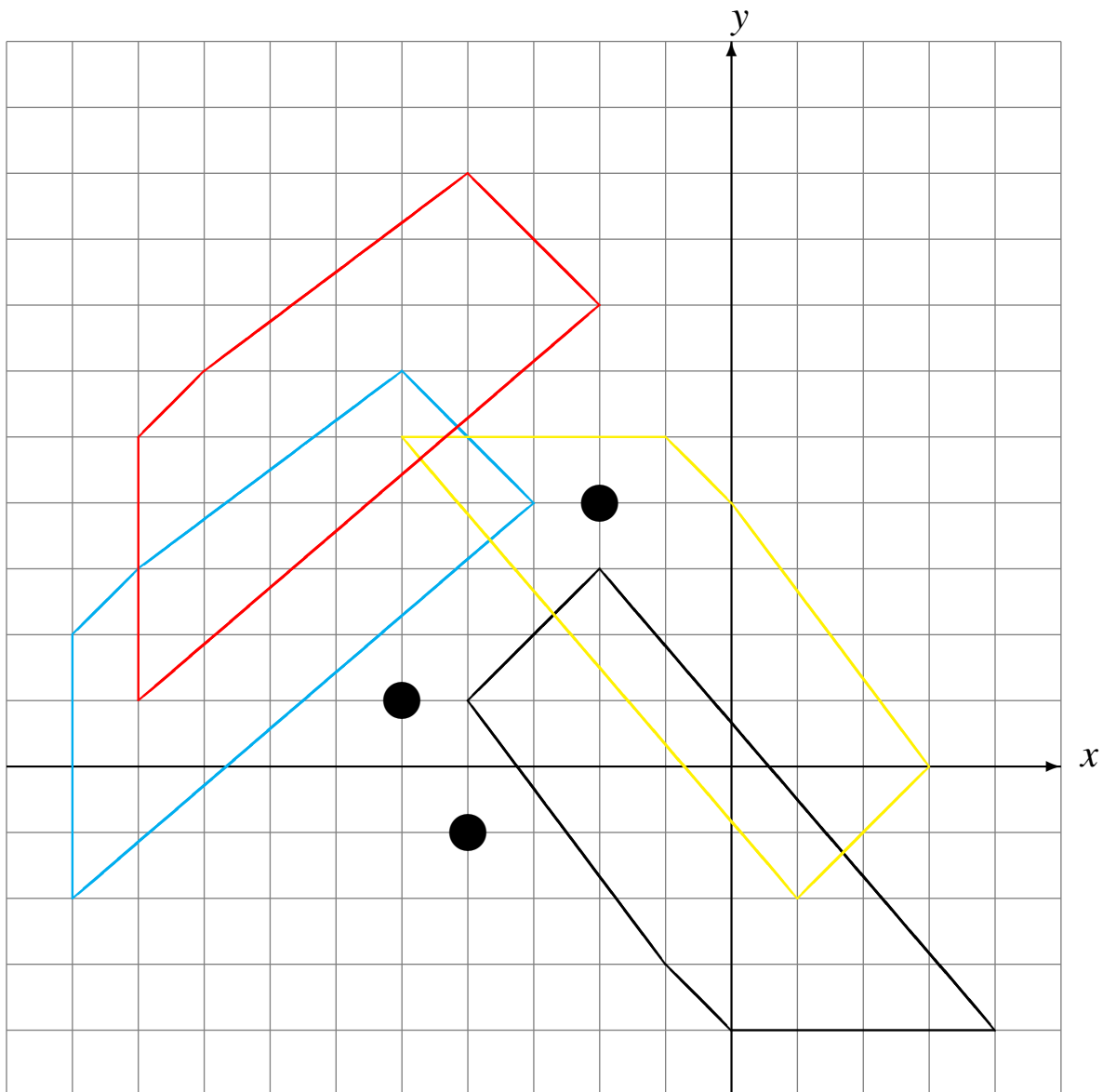

## Rotations (B)

Draw the intermediate and rotated images.

Rotate  $180^\circ$  about  $(5, 0)$ .

Rotate  $180^\circ$  about  $(-5, -2)$ .

Rotate  $90^\circ$  clockwise about  $(-4, -5)$ .

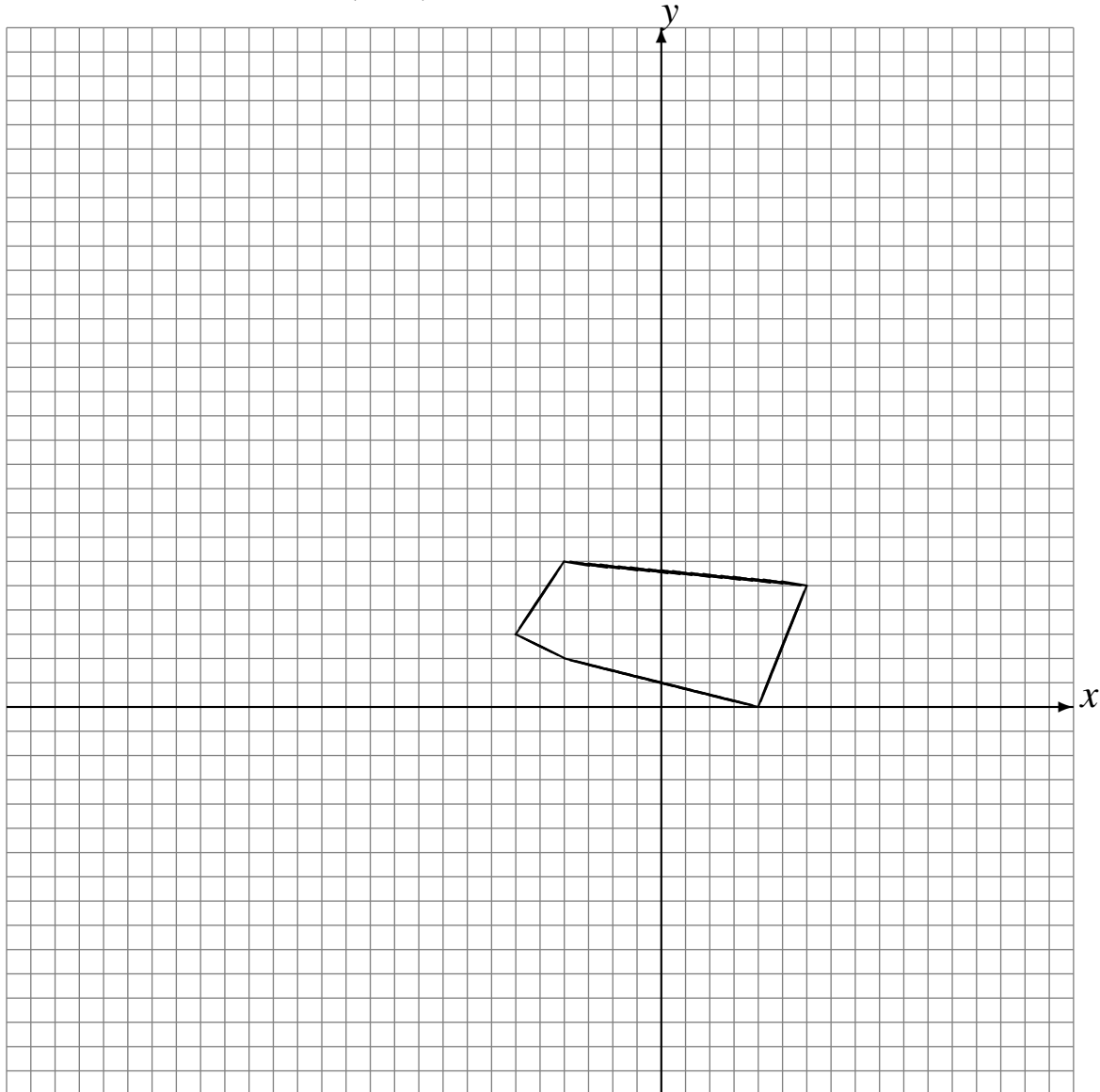

# Rotations (B) Answers

Draw the intermediate and rotated images.

Rotate  $180^\circ$  about  $(5, 0)$ .

Rotate  $180^\circ$  about  $(-5, -2)$ .

Rotate  $90^\circ$  clockwise about  $(-4, -5)$ .

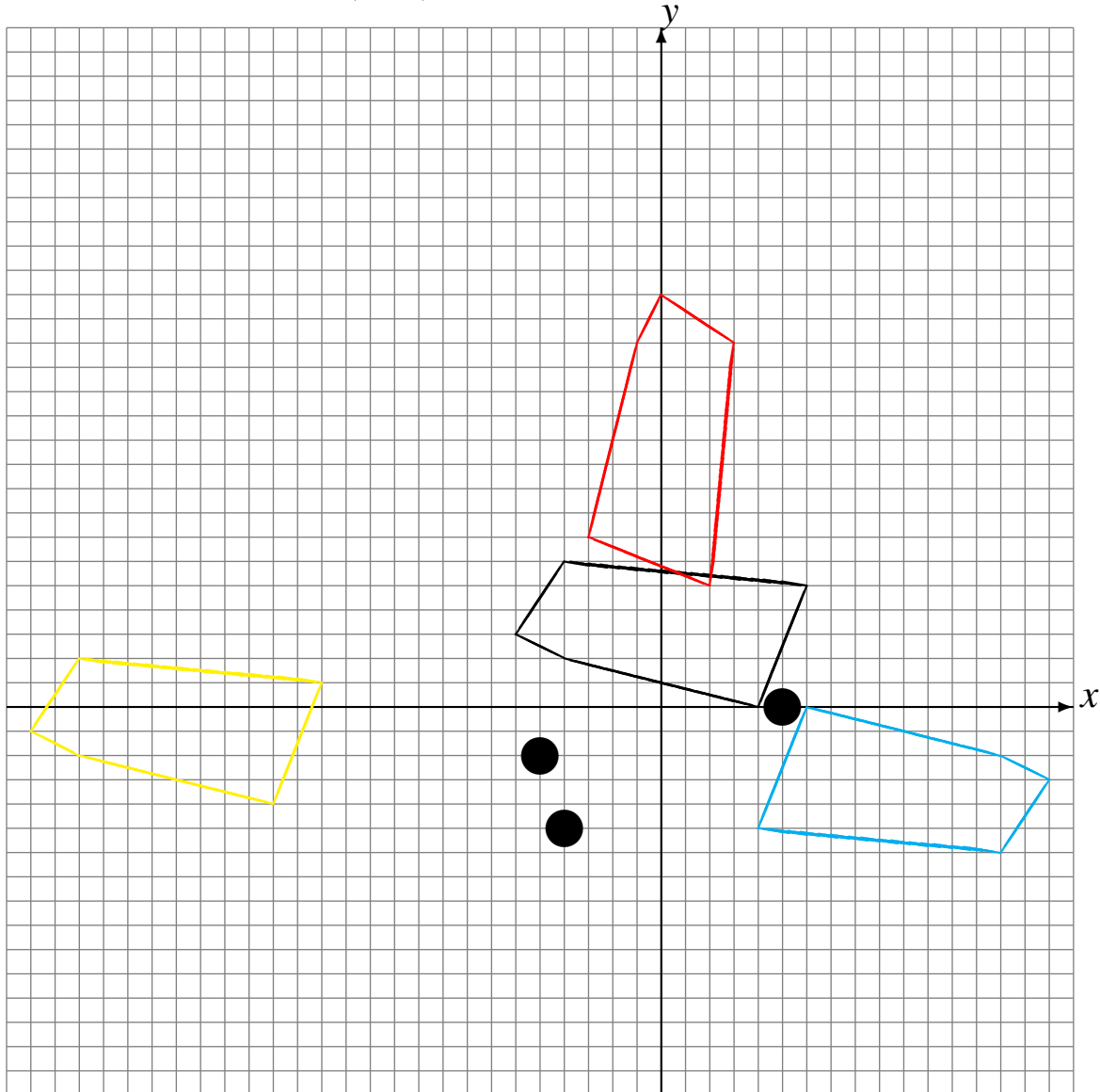

## Rotations (C)

Draw the intermediate and rotated images.

Rotate  $180^\circ$  about  $(-5, -5)$ .

Rotate  $180^\circ$  about  $(-2, -5)$ .

Rotate  $90^\circ$  clockwise about  $(3, -2)$ .

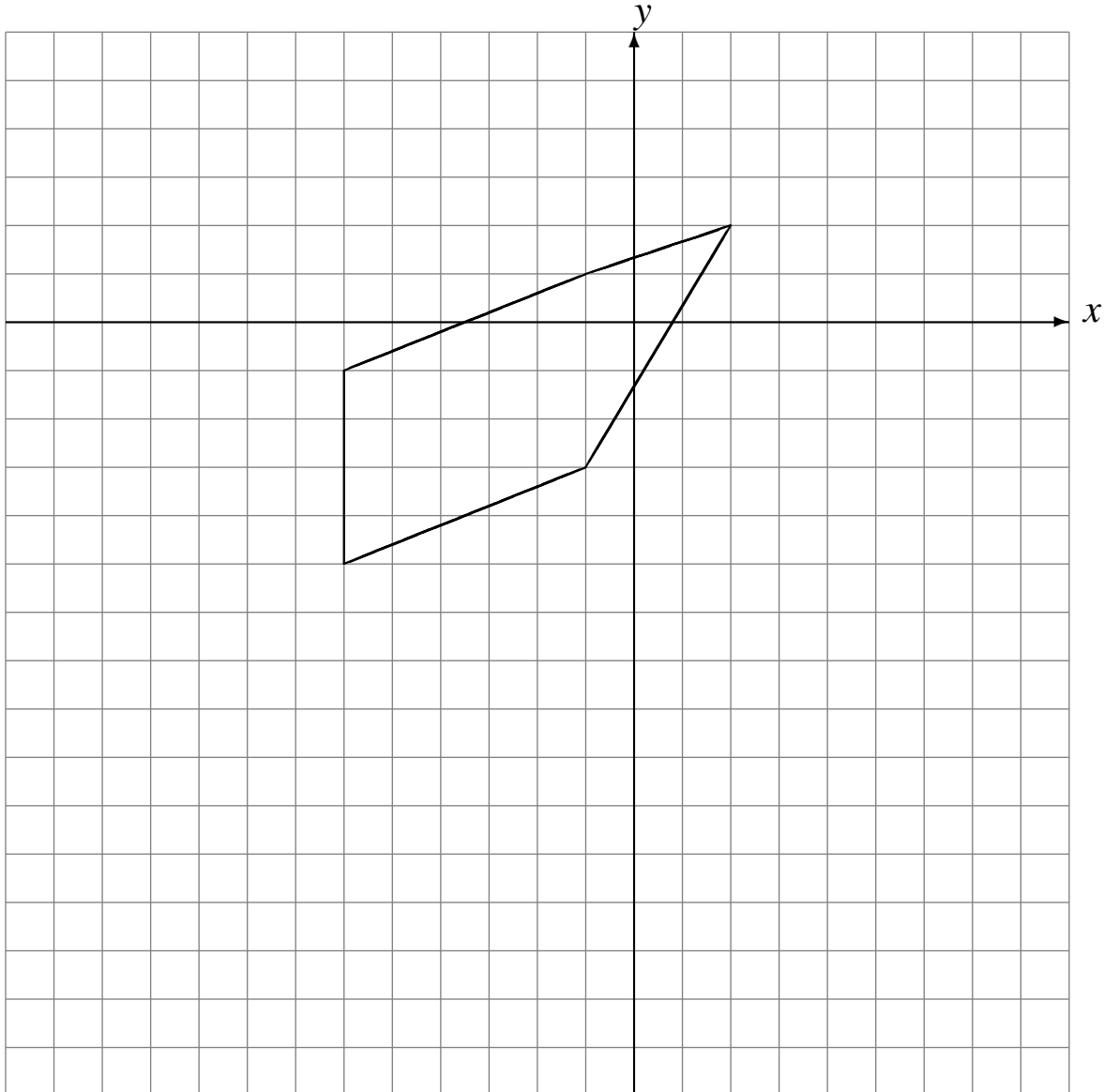

# Rotations (C) Answers

Draw the intermediate and rotated images.

Rotate  $180^\circ$  about  $(-5, -5)$ .

Rotate  $180^\circ$  about  $(-2, -5)$ .

Rotate  $90^\circ$  clockwise about  $(3, -2)$ .

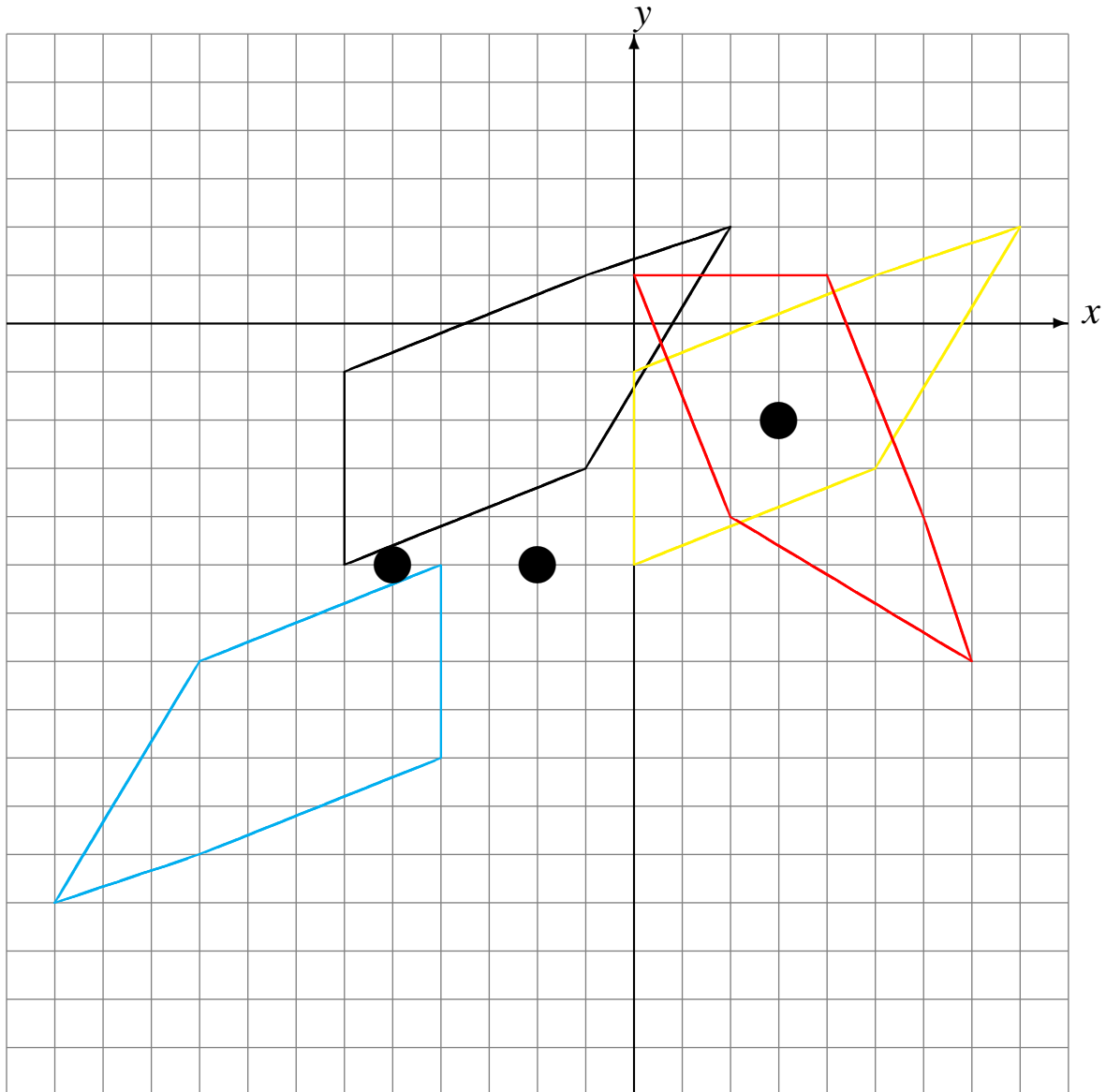

## Rotations (D)

Draw the intermediate and rotated images.

Rotate  $90^\circ$  clockwise about  $(-4, 1)$ .

Rotate  $90^\circ$  counterclockwise about  $(2, 1)$ .

Rotate  $180^\circ$  about  $(3, -1)$ .

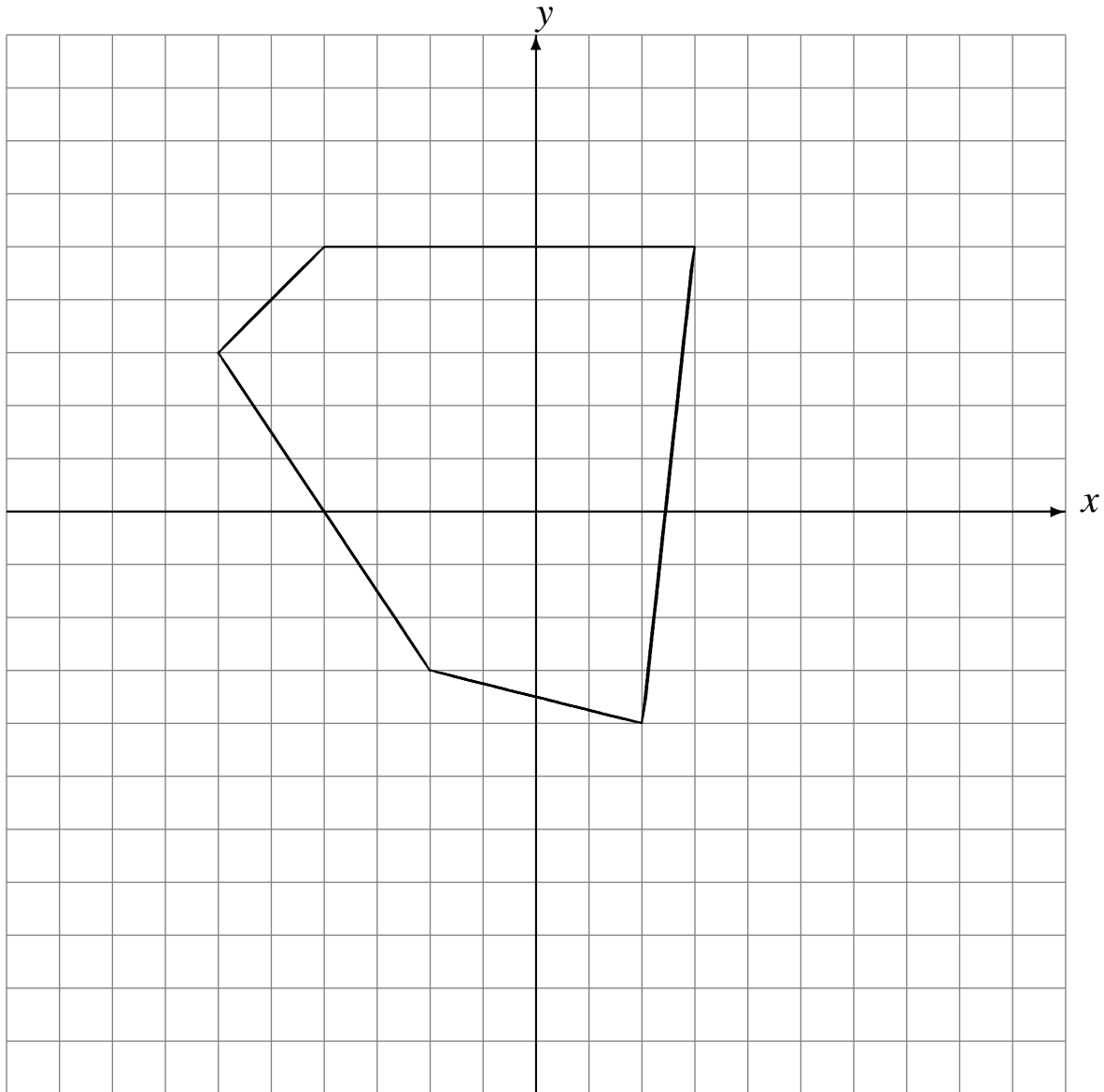

# Rotations (D) Answers

Draw the intermediate and rotated images.

- Rotate  $90^\circ$  clockwise about  $(-4, 1)$ .
- Rotate  $90^\circ$  counterclockwise about  $(2, 1)$ .
- Rotate  $180^\circ$  about  $(3, -1)$ .

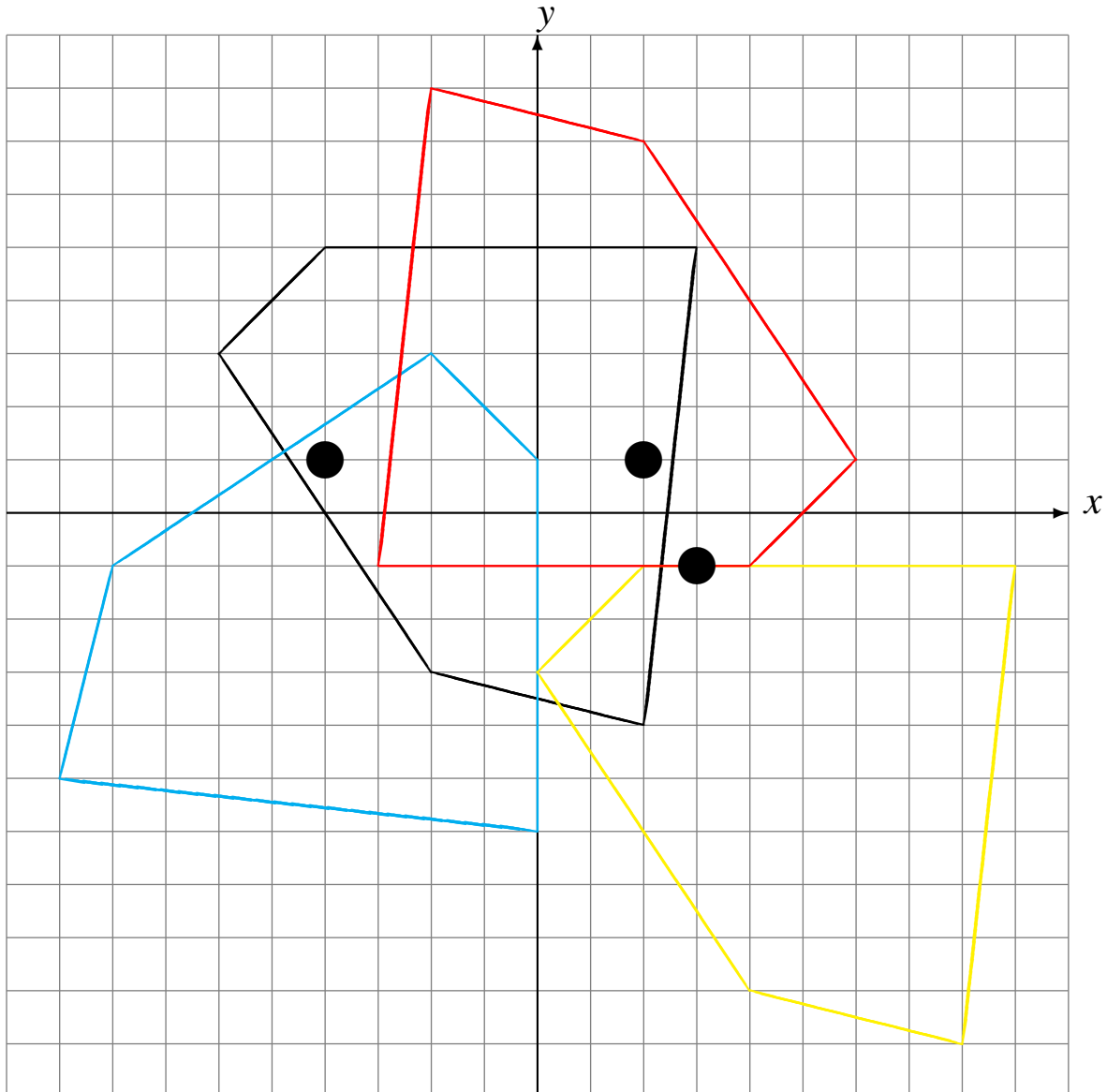



## Rotations (E)

Draw the intermediate and rotated images.

Rotate  $90^\circ$  clockwise about  $(-5, -2)$ .

Rotate  $180^\circ$  about  $(-2, -1)$ .

Rotate  $180^\circ$  about  $(3, 5)$ .

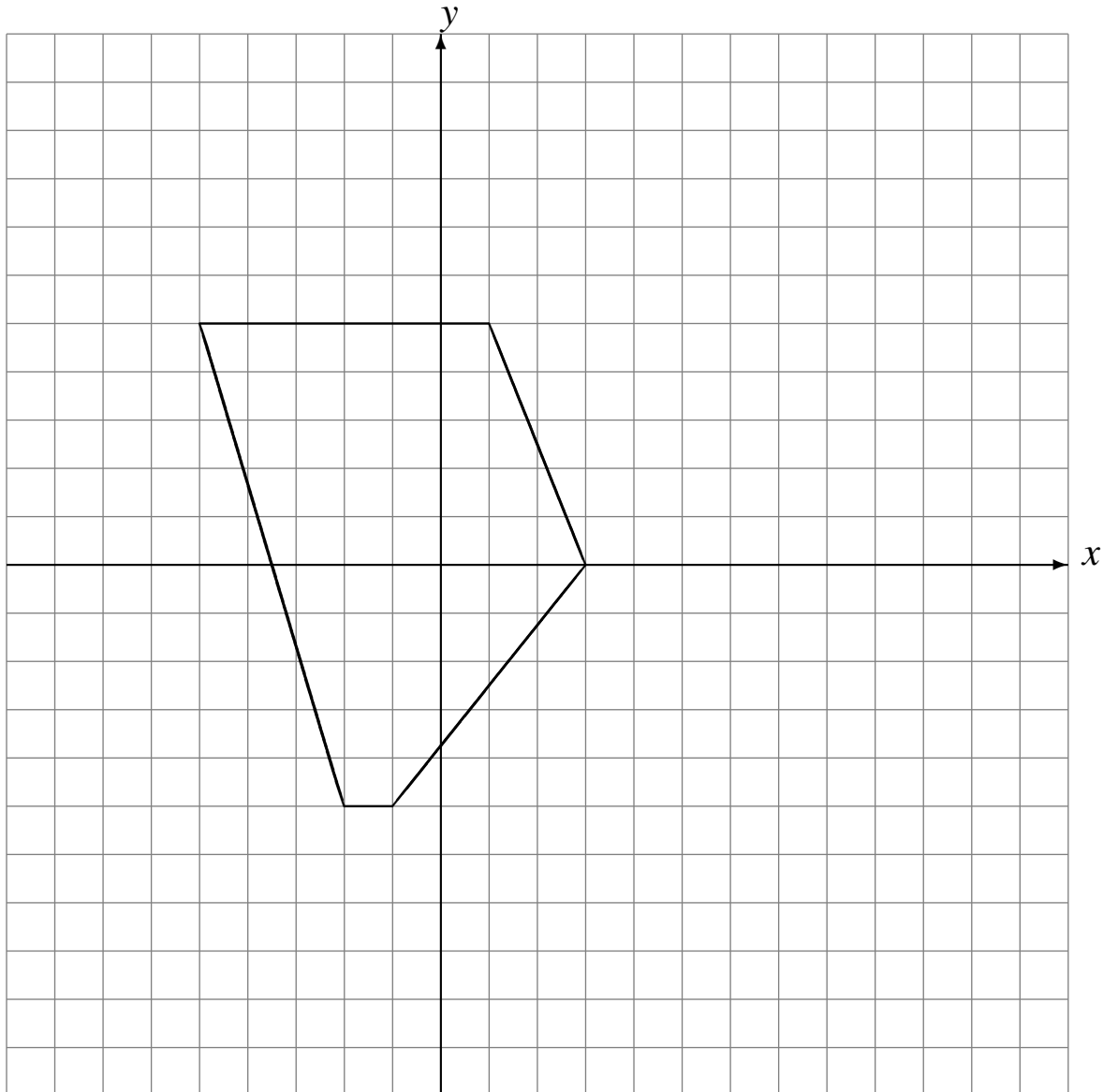

# Rotations (E) Answers

Draw the intermediate and rotated images.

Rotate  $90^\circ$  clockwise about  $(-5, -2)$ .

Rotate  $180^\circ$  about  $(-2, -1)$ .

Rotate  $180^\circ$  about  $(3, 5)$ .

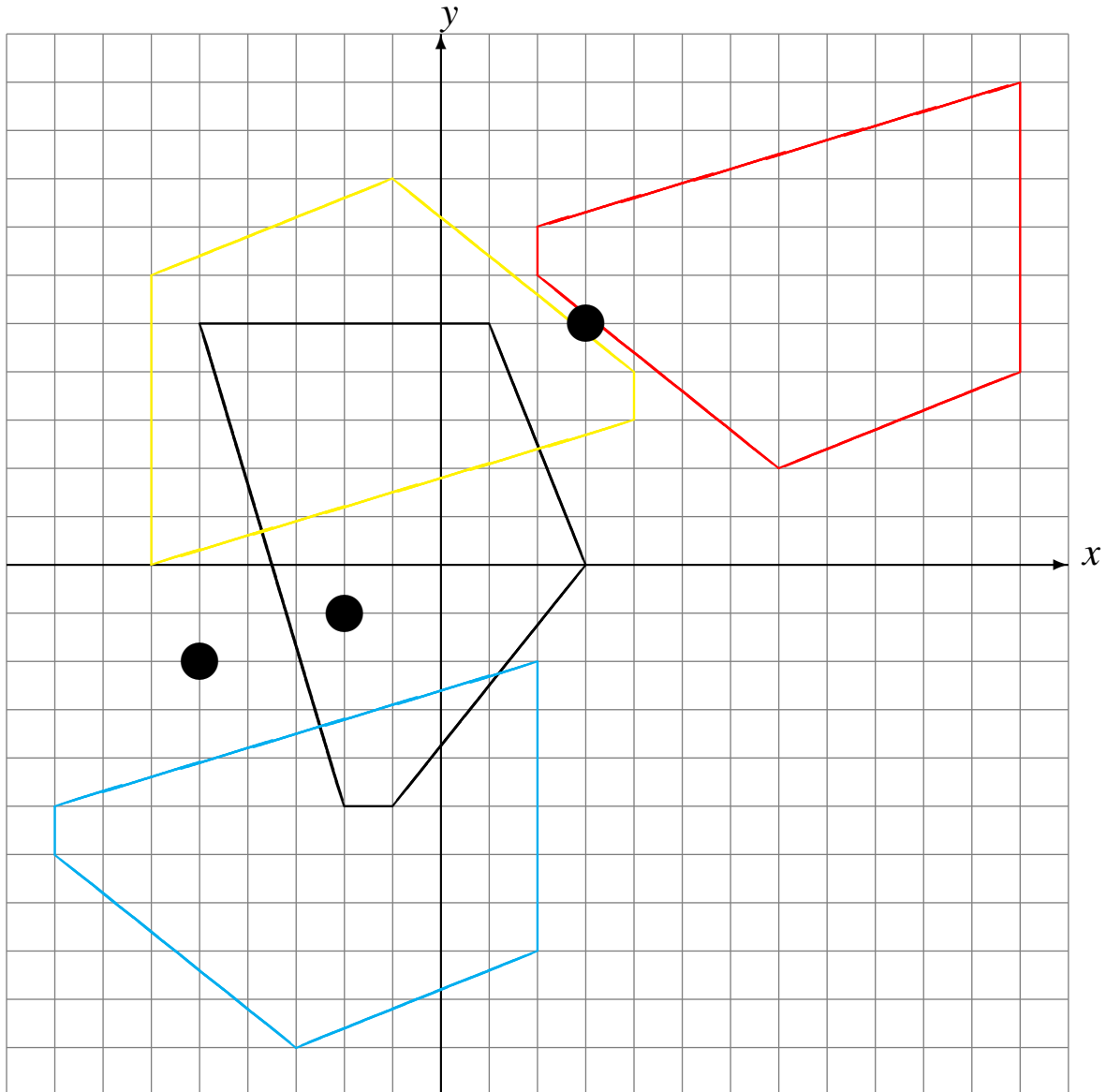

# Rotations (F)

Draw the intermediate and rotated images.

Rotate  $90^\circ$  clockwise about  $(-4, -1)$ .

Rotate  $90^\circ$  counterclockwise about  $(-1, 1)$ .

Rotate  $90^\circ$  counterclockwise about  $(1, -4)$ .

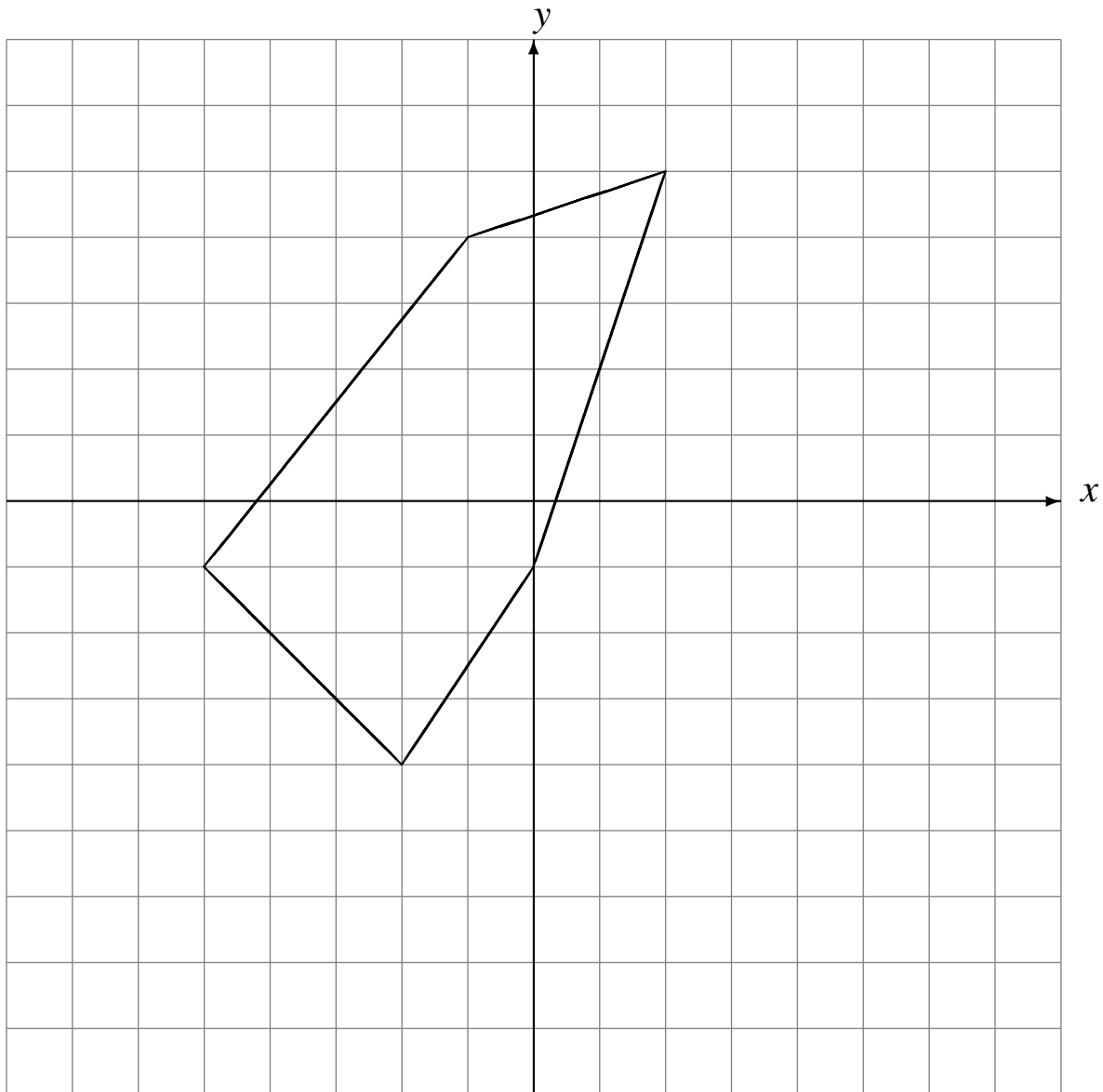

# Rotations (F) Answers

Draw the intermediate and rotated images.

Rotate  $90^\circ$  clockwise about  $(-4, -1)$ .

Rotate  $90^\circ$  counterclockwise about  $(-1, 1)$ .

Rotate  $90^\circ$  counterclockwise about  $(1, -4)$ .

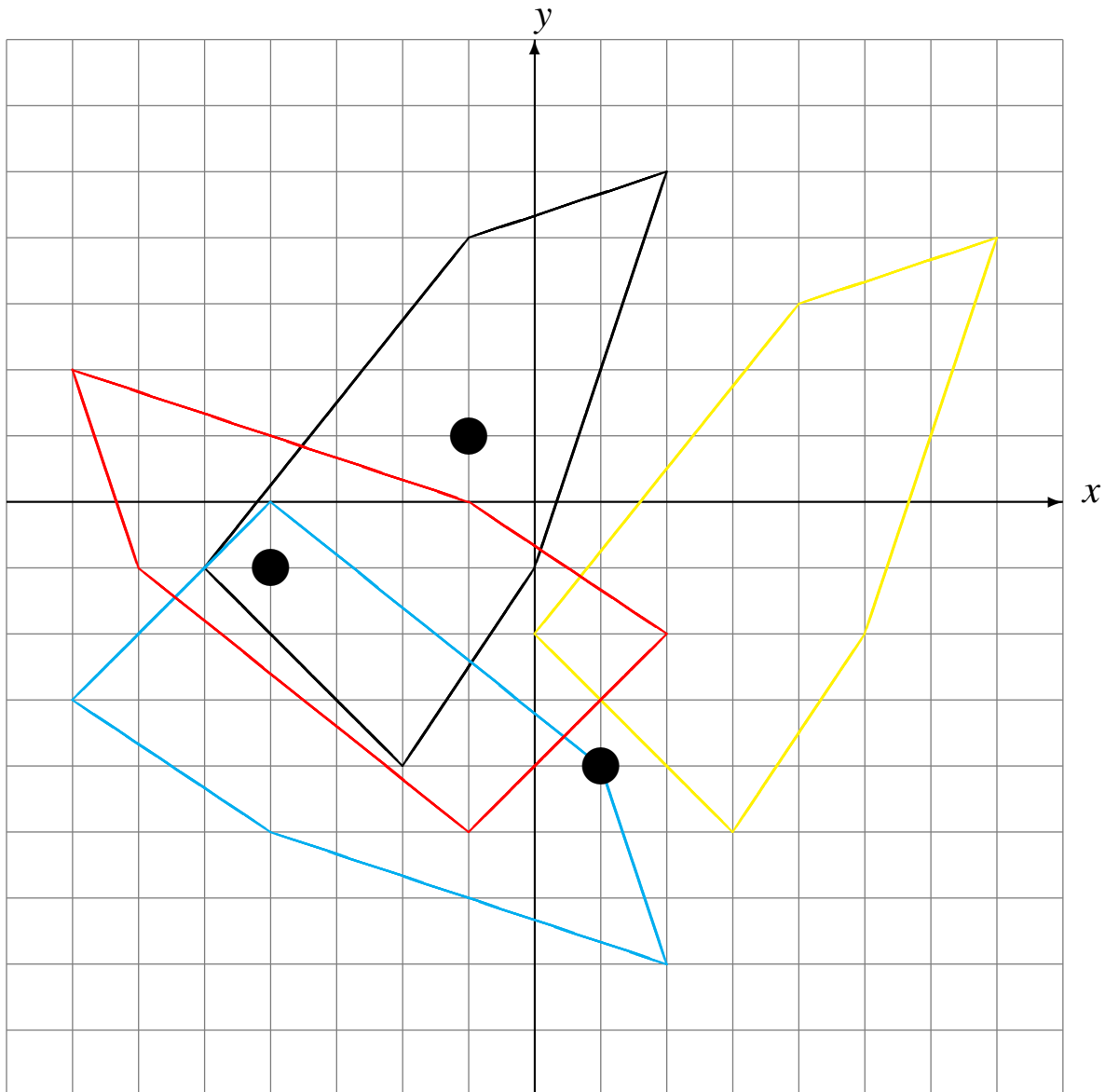

# Rotations (G)

Draw the intermediate and rotated images.

Rotate  $180^\circ$  about  $(4, 5)$ .

Rotate  $90^\circ$  counterclockwise about  $(-3, -1)$ .

Rotate  $90^\circ$  clockwise about  $(-1, -2)$ .

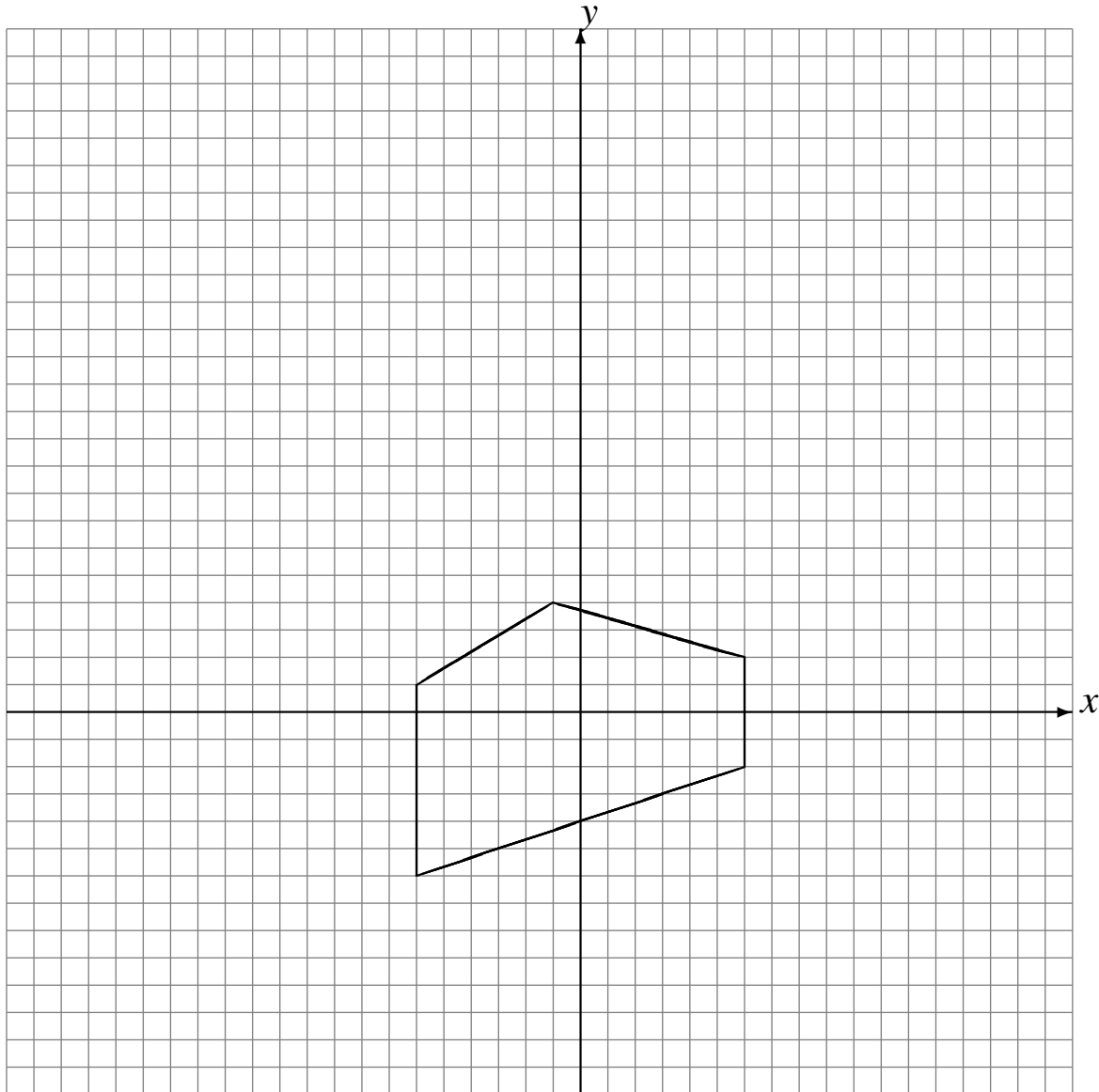

# Rotations (G) Answers

Draw the intermediate and rotated images.

Rotate  $180^\circ$  about  $(4, 5)$ .

Rotate  $90^\circ$  counterclockwise about  $(-3, -1)$ .

Rotate  $90^\circ$  clockwise about  $(-1, -2)$ .

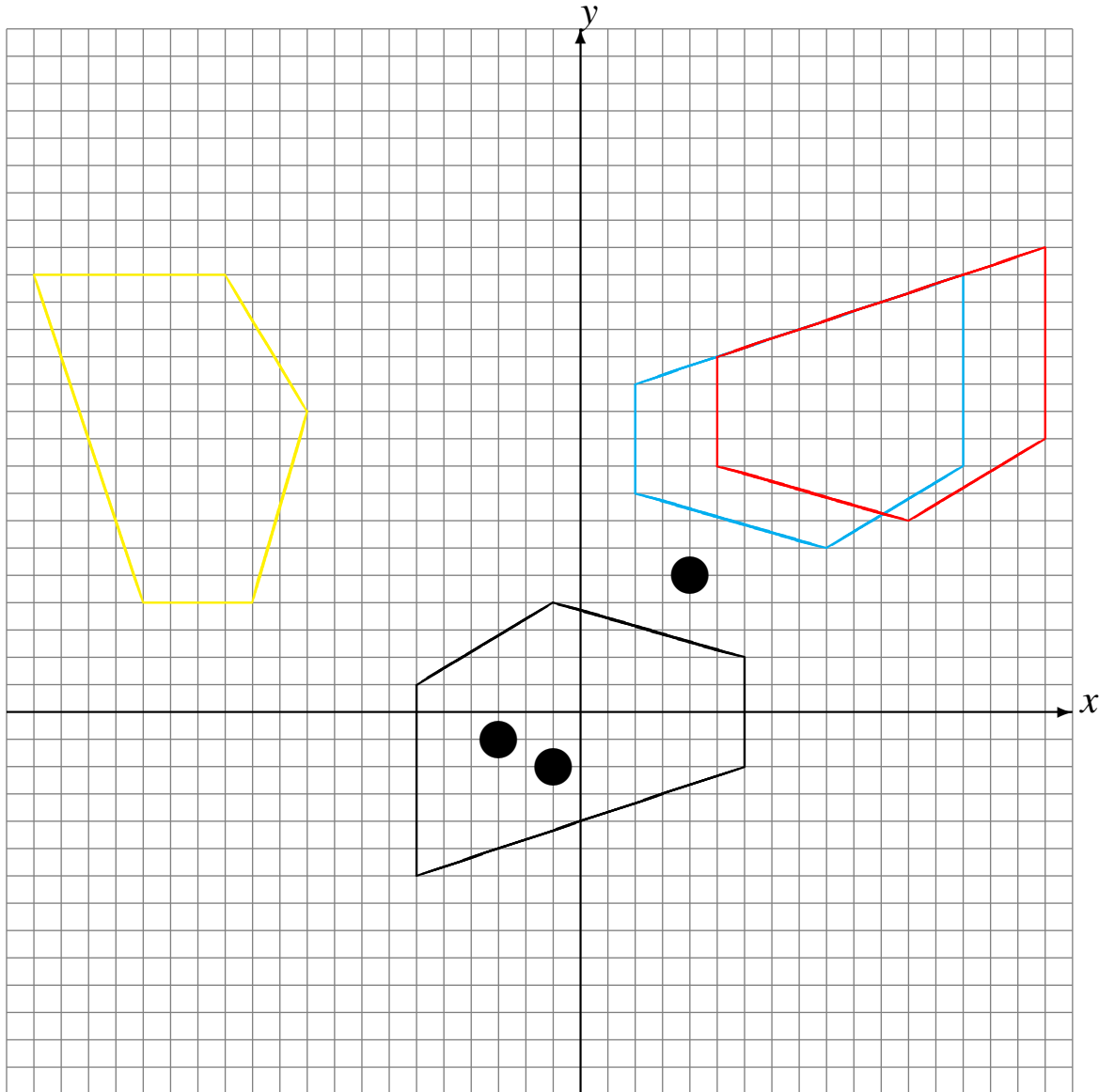

# Rotations (H)

Draw the intermediate and rotated images.

Rotate  $180^\circ$  about  $(-2, 2)$ .

Rotate  $90^\circ$  clockwise about  $(3, 0)$ .

Rotate  $90^\circ$  clockwise about  $(-1, -2)$ .

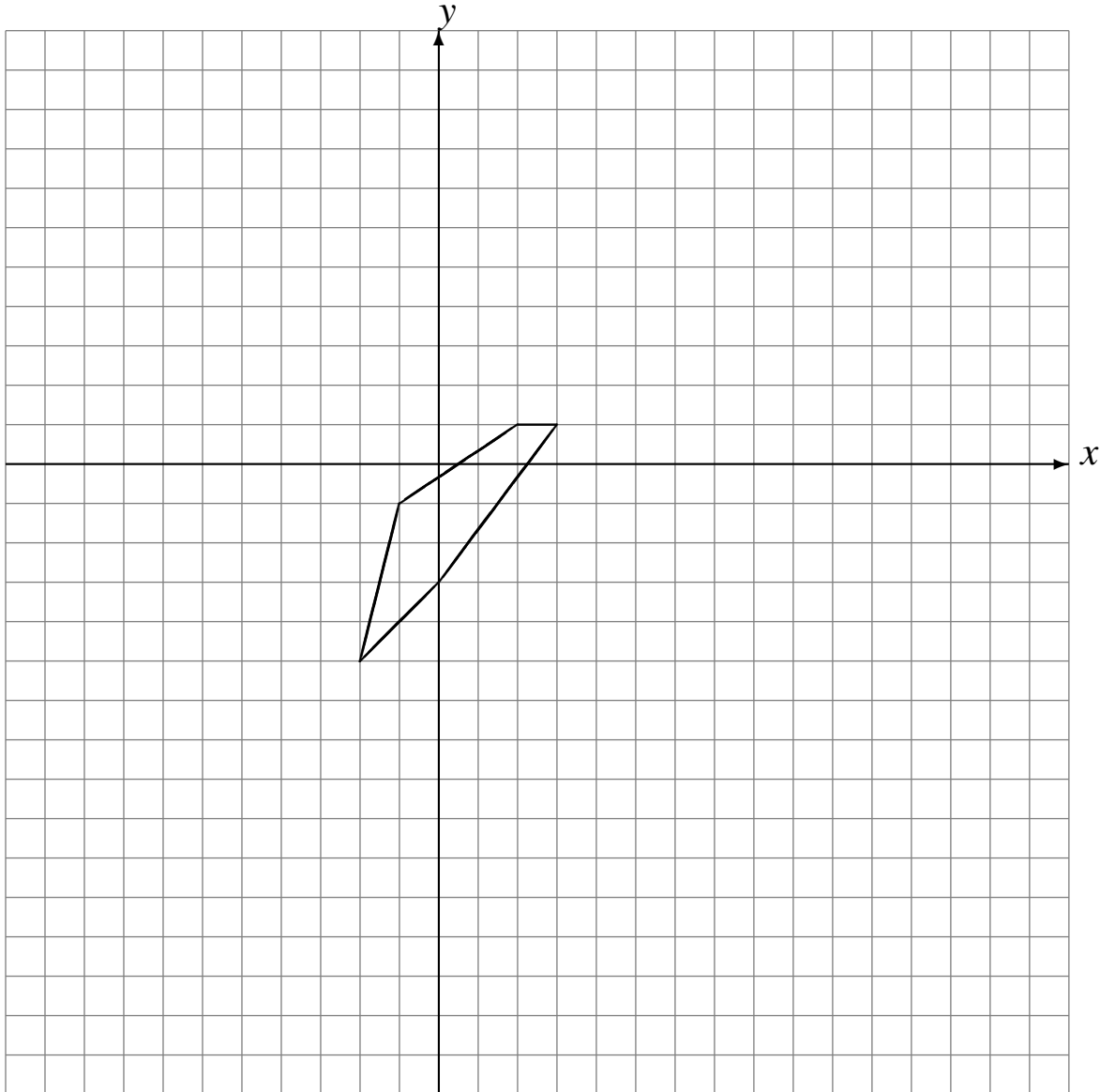

# Rotations (H) Answers

Draw the intermediate and rotated images.

Rotate  $180^\circ$  about  $(-2, 2)$ .

Rotate  $90^\circ$  clockwise about  $(3, 0)$ .

Rotate  $90^\circ$  clockwise about  $(-1, -2)$ .

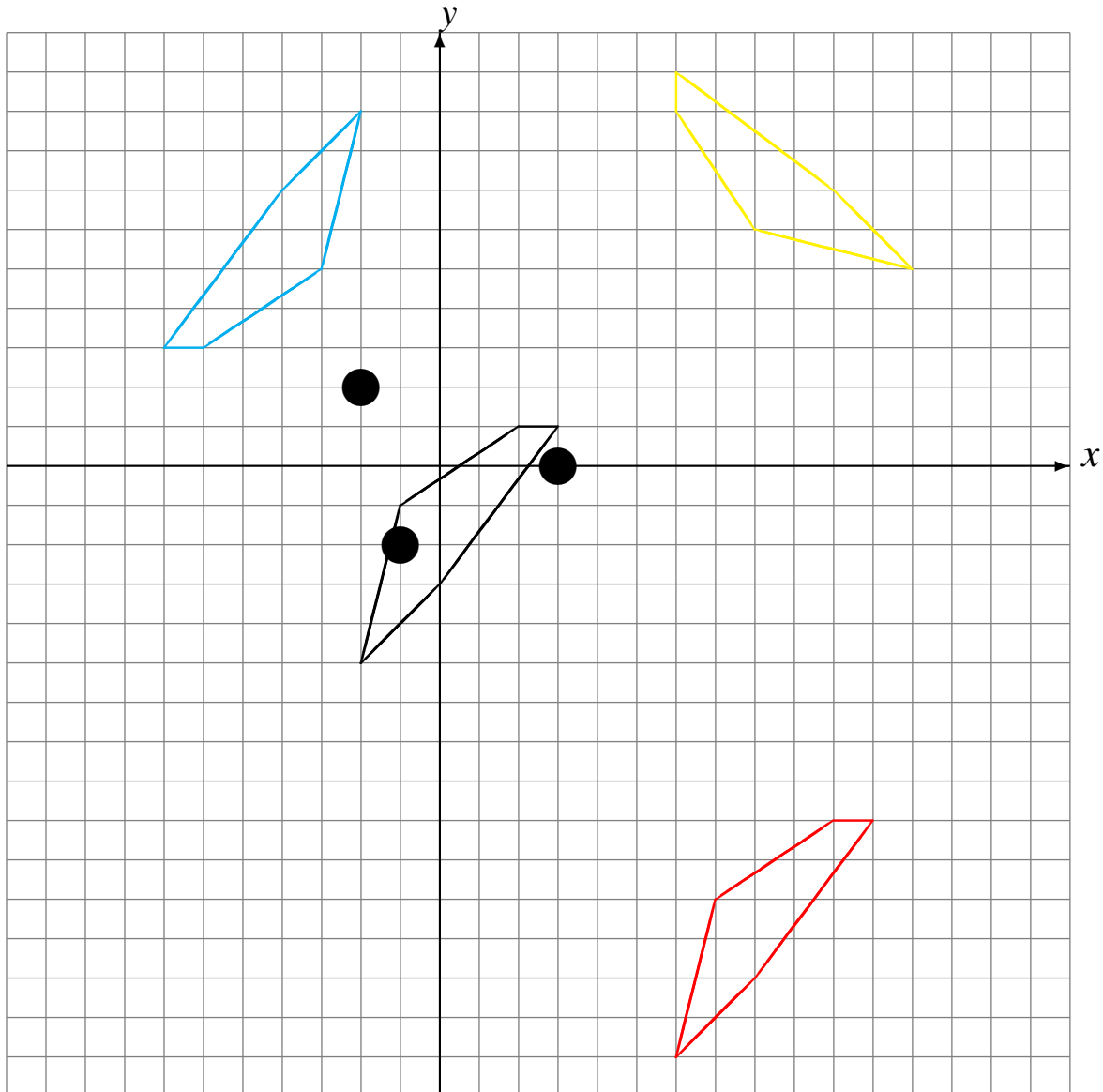



# Rotations (I)

Draw the intermediate and rotated images.

Rotate  $90^\circ$  counterclockwise about  $(-5, -2)$ .

Rotate  $180^\circ$  about  $(5, -4)$ .

Rotate  $90^\circ$  clockwise about  $(-3, -2)$ .

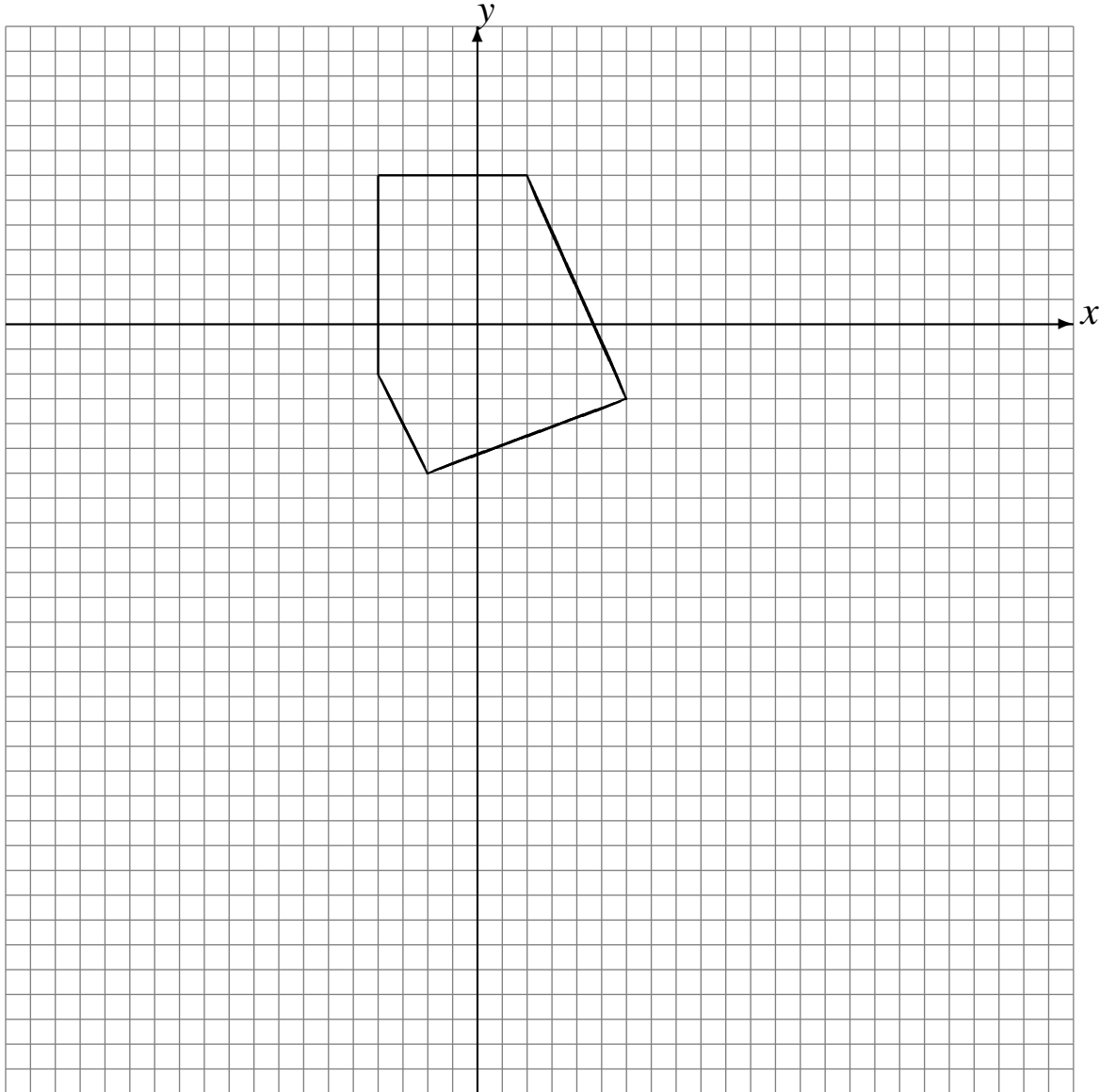

# Rotations (I) Answers

Draw the intermediate and rotated images.

Rotate  $90^\circ$  counterclockwise about  $(-5, -2)$ .

Rotate  $180^\circ$  about  $(5, -4)$ .

Rotate  $90^\circ$  clockwise about  $(-3, -2)$ .

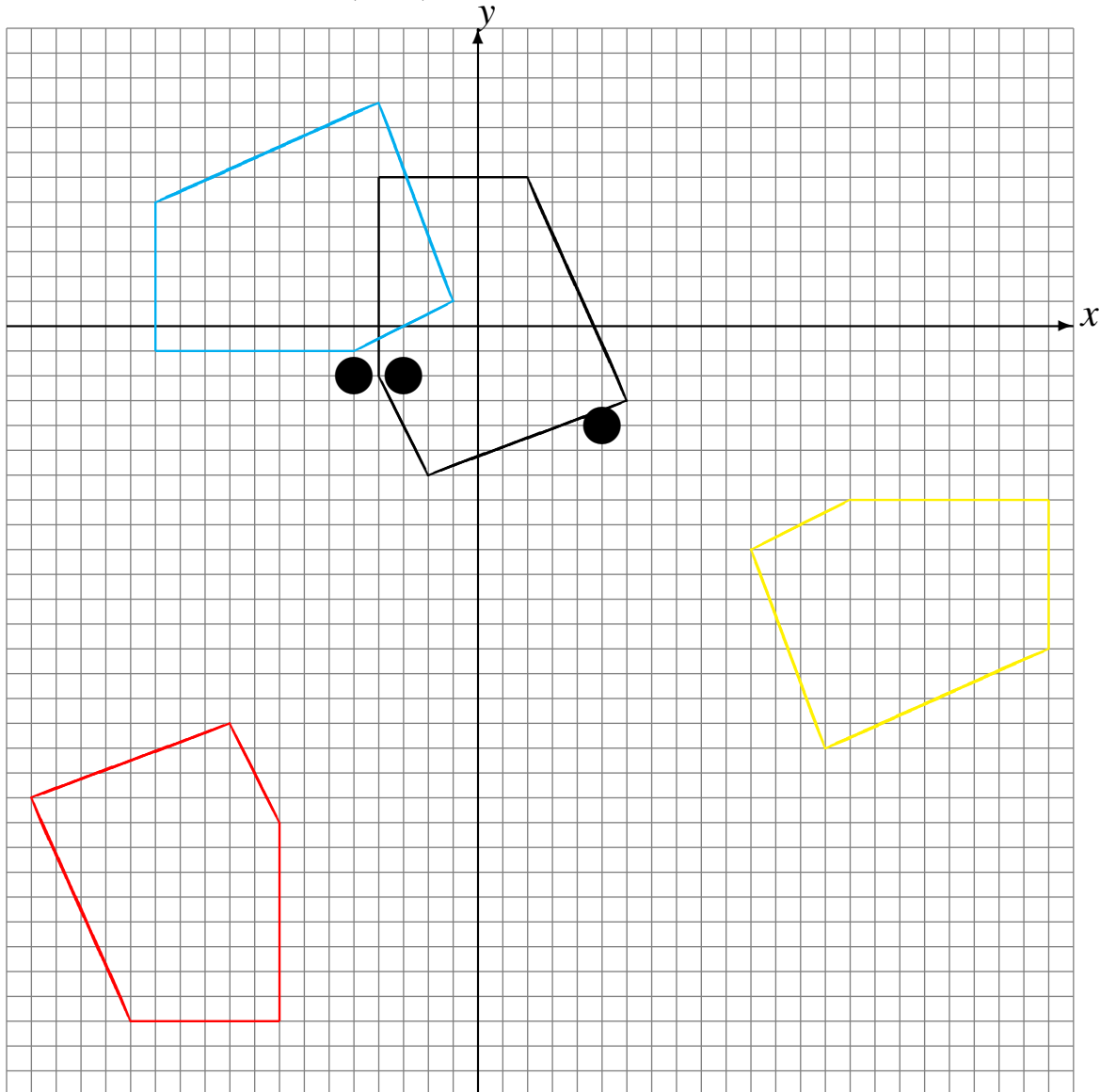

# Rotations (J)

Draw the intermediate and rotated images.

Rotate  $90^\circ$  counterclockwise about  $(1, -5)$ .

Rotate  $180^\circ$  about  $(3, 4)$ .

Rotate  $90^\circ$  counterclockwise about  $(5, -5)$ .

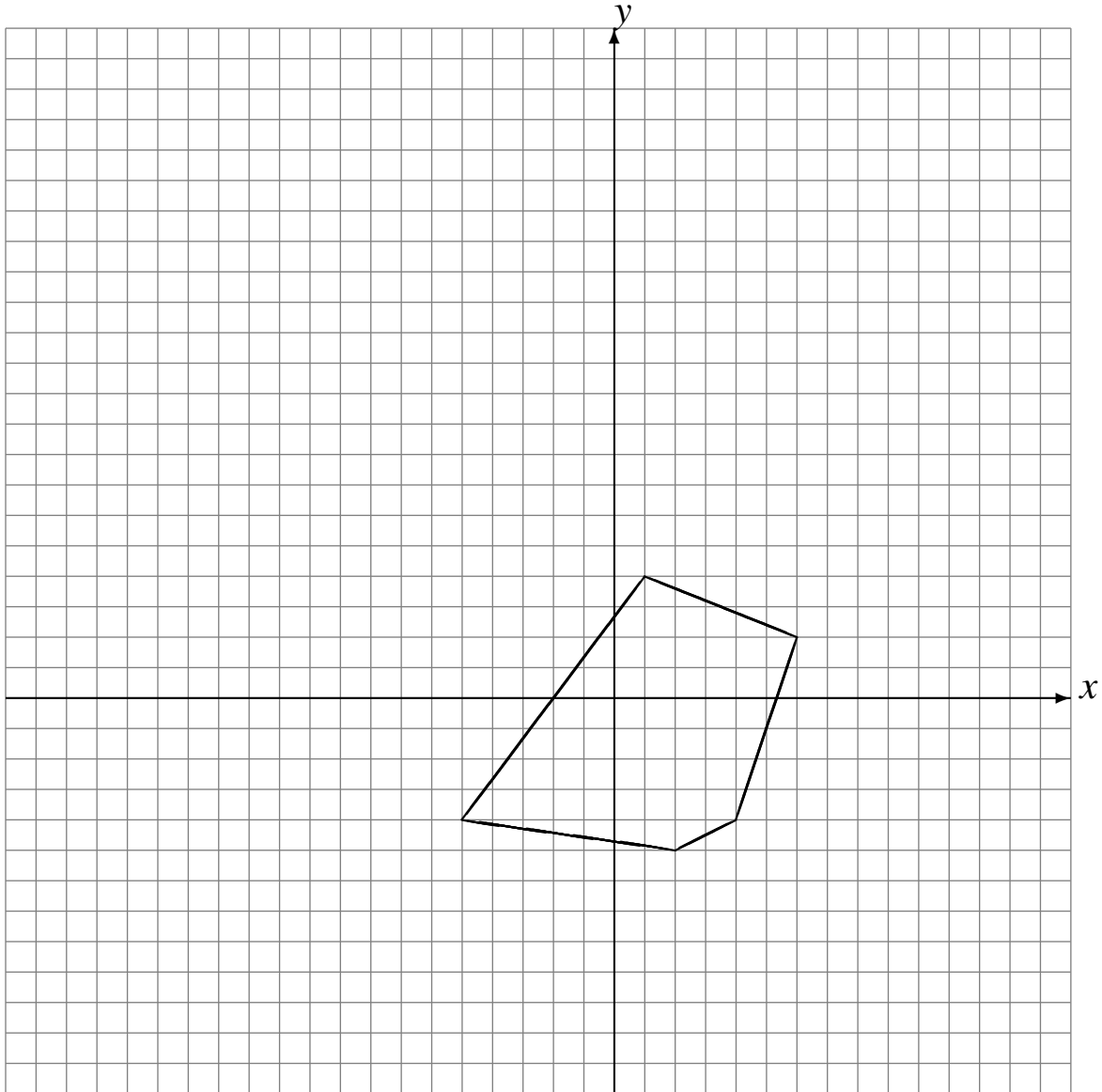

# Rotations (J) Answers

Draw the intermediate and rotated images.

Rotate  $90^\circ$  counterclockwise about  $(1, -5)$ .

Rotate  $180^\circ$  about  $(3, 4)$ .

Rotate  $90^\circ$  counterclockwise about  $(5, -5)$ .

