

Translations (A)

Draw each translated image.

Translate by $(-2, 4)$.

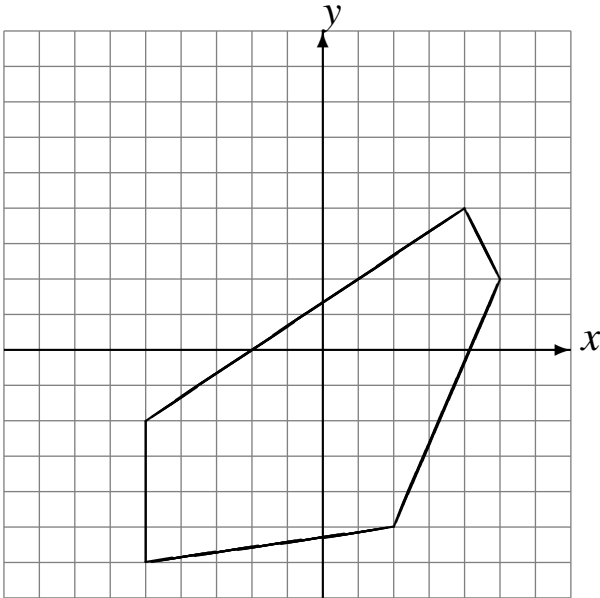

Translate by $(5, -2)$.

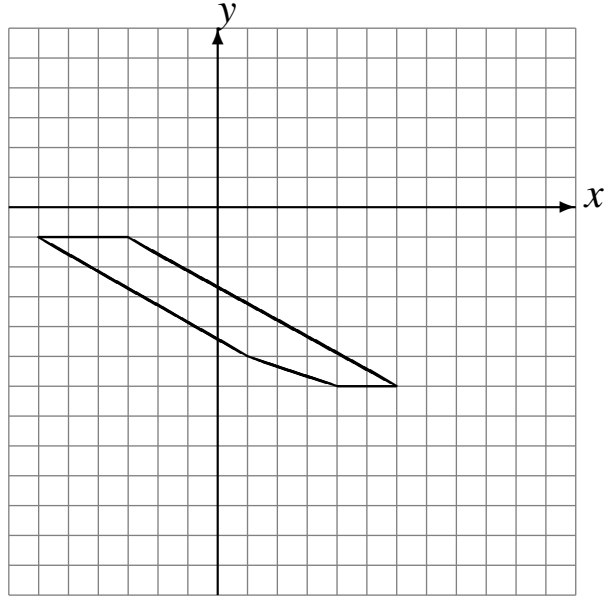

Translate by $(-3, 1)$.

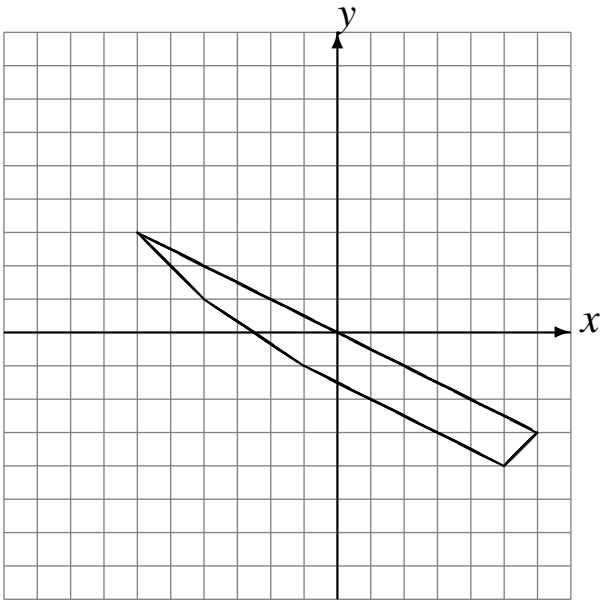

Translate by $(-3, 5)$.

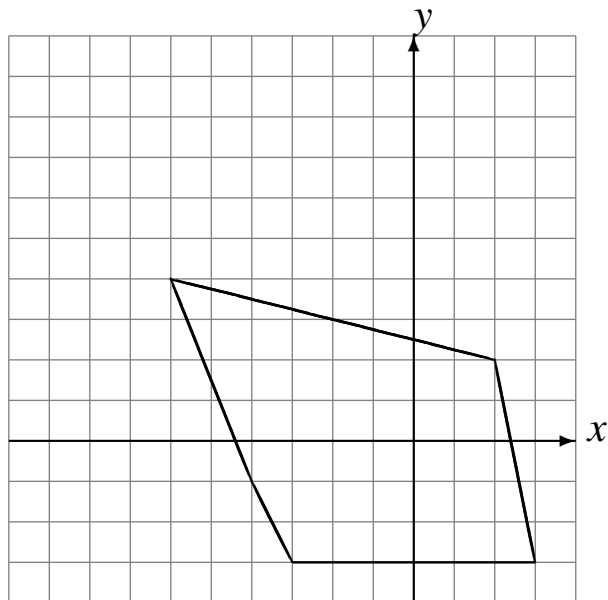

Translations (A) Answers

Draw each translated image.

Translate by $(-2, 4)$.

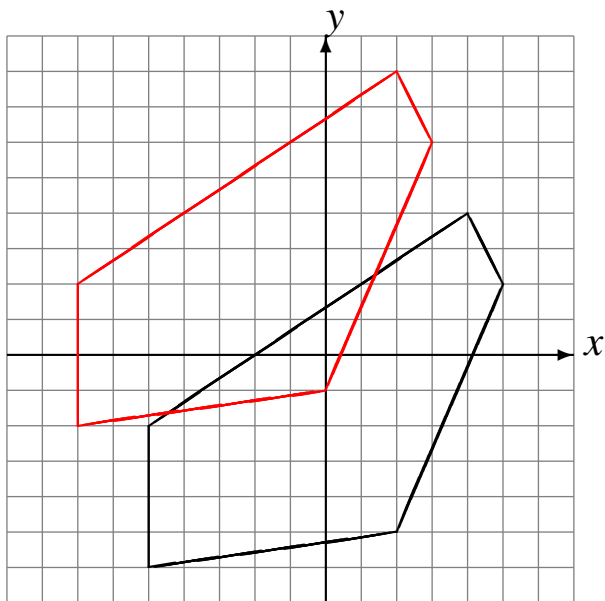

Translate by $(5, -2)$.

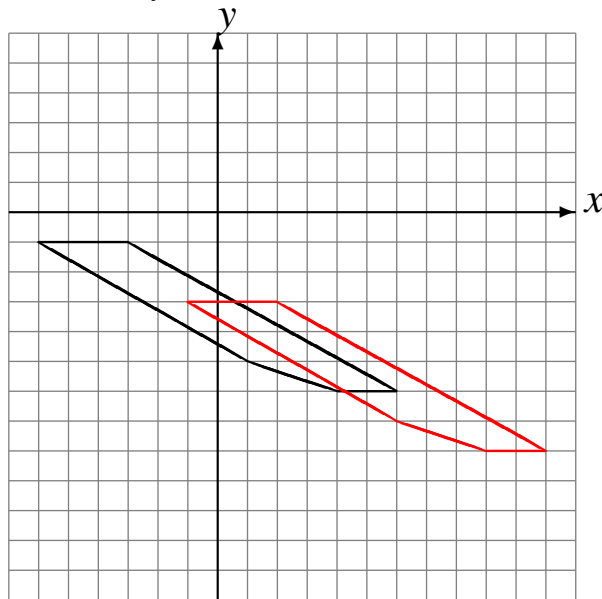

Translate by $(-3, 1)$.

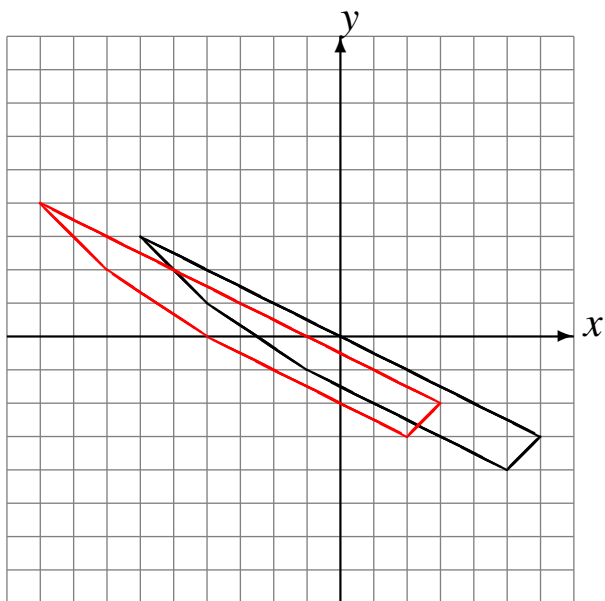

Translate by $(-3, 5)$.

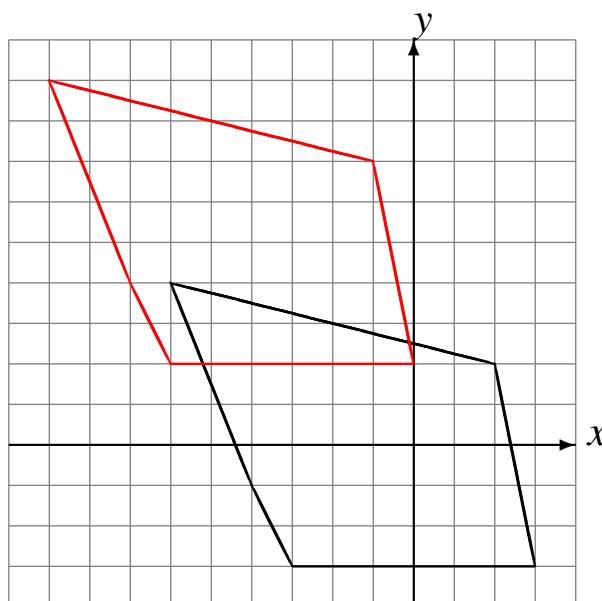

Translations (B)

Draw each translated image.

Translate by $(4, -6)$.

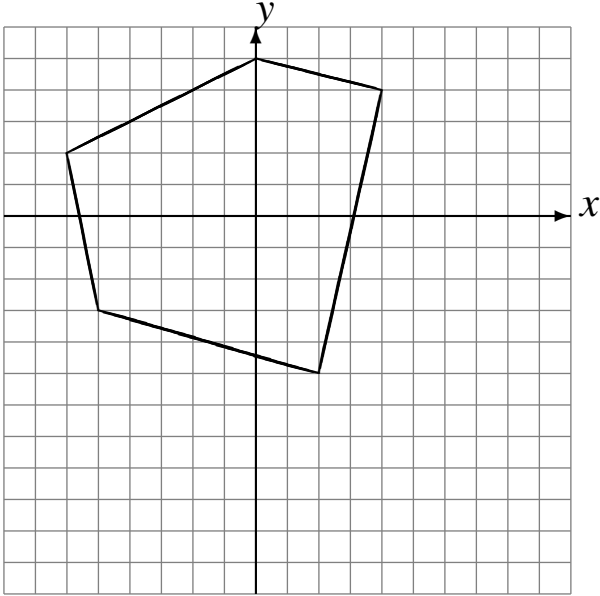

Translate by $(4, 3)$.

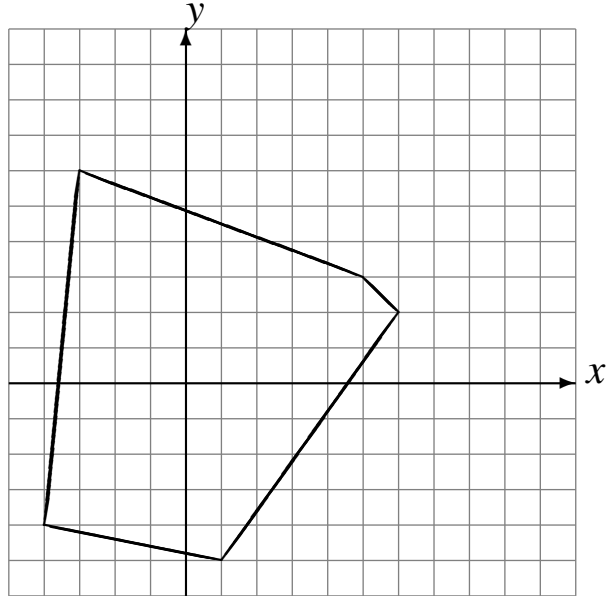

Translate by $(-5, 6)$.

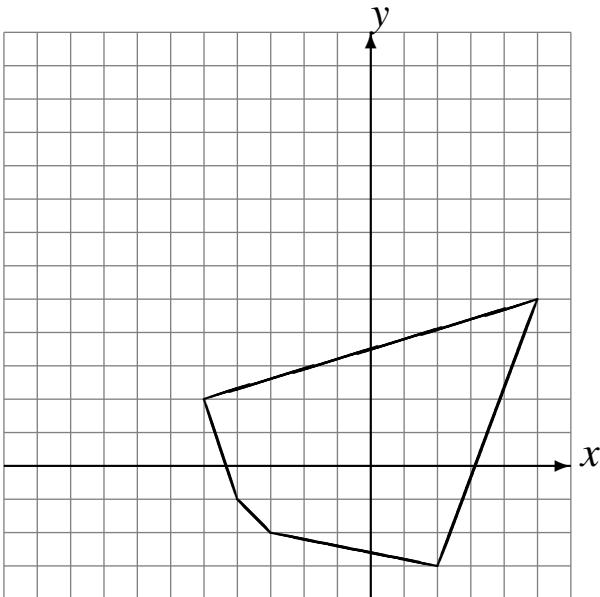

Translate by $(-2, 6)$.

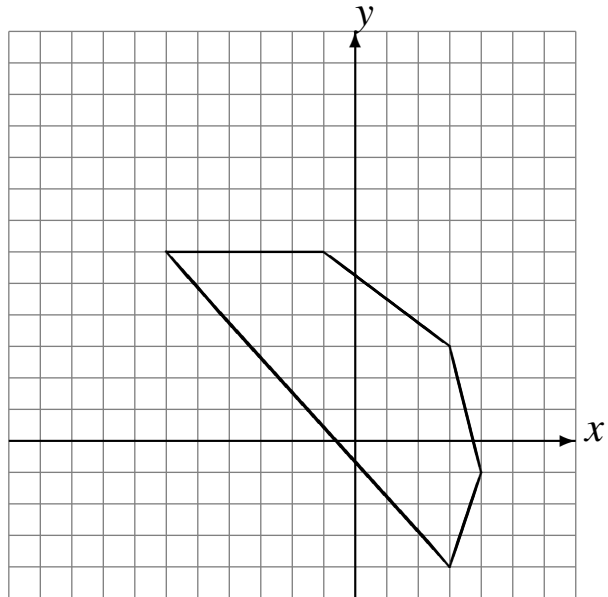

Translations (B) Answers

Draw each translated image.

Translate by $(4, -6)$.

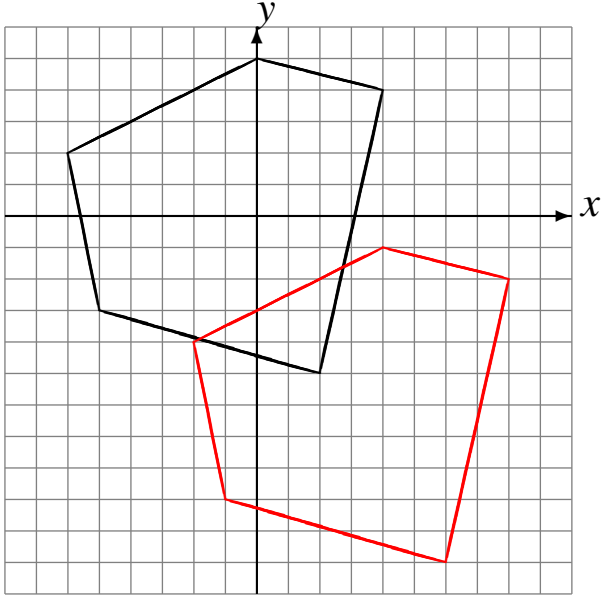

Translate by $(4, 3)$.

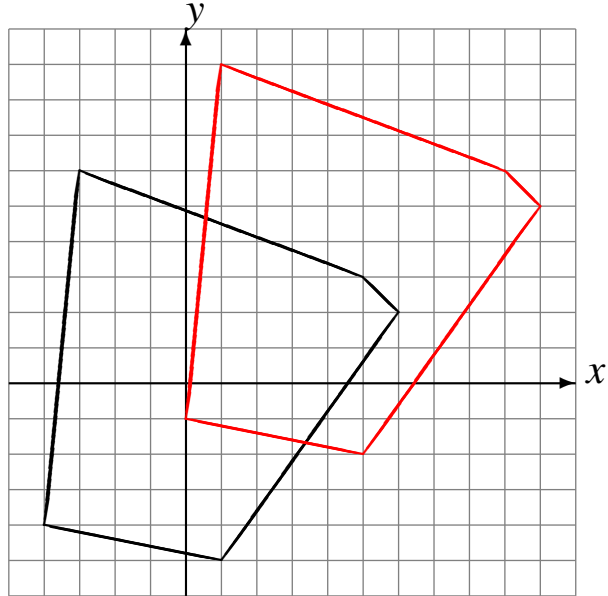

Translate by $(-5, 6)$.

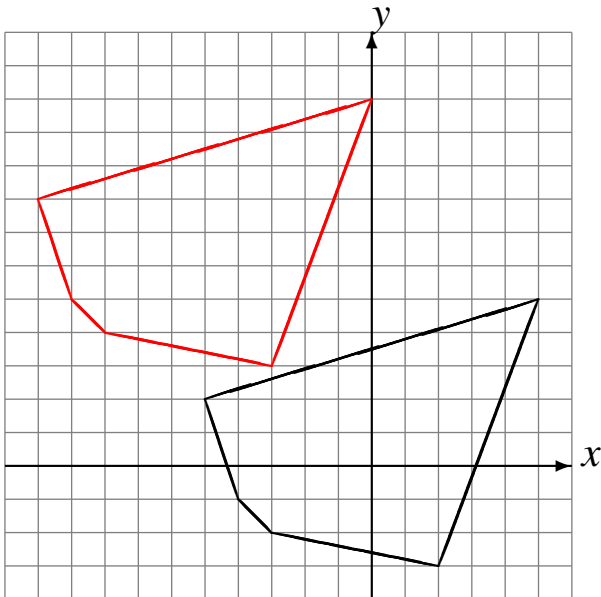

Translate by $(-2, 6)$.

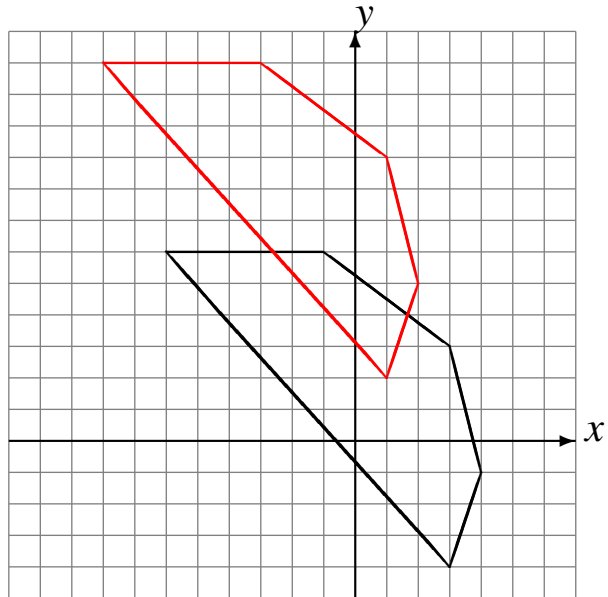

Translations (C)

Draw each translated image.

Translate by $(3, -4)$.

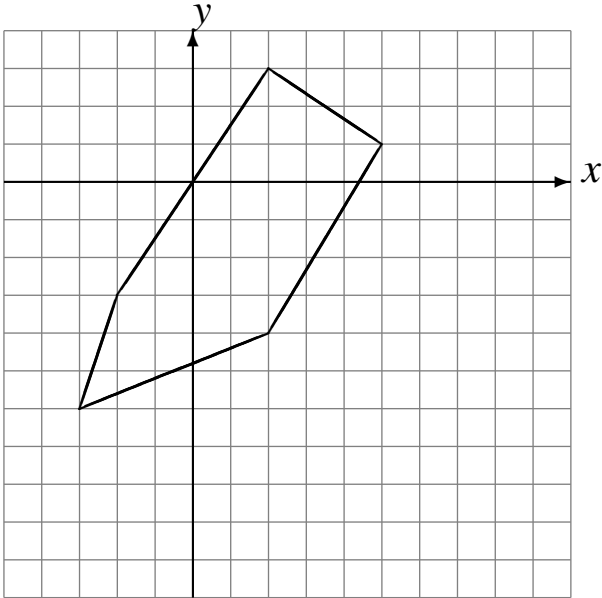

Translate by $(-1, 1)$.

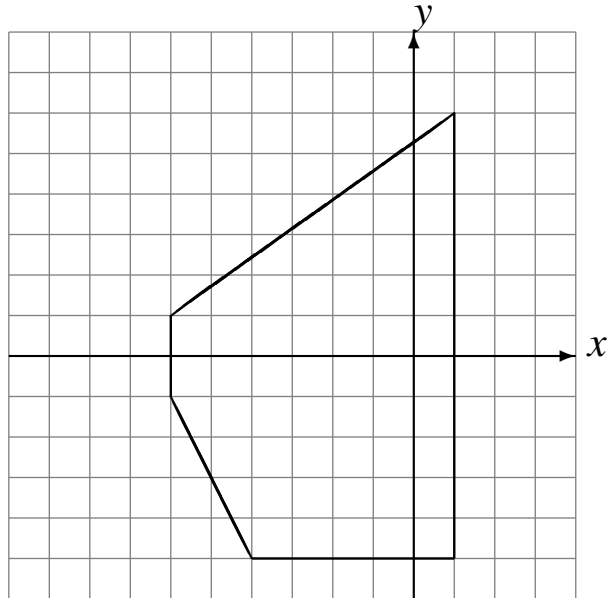

Translate by $(4, 1)$.

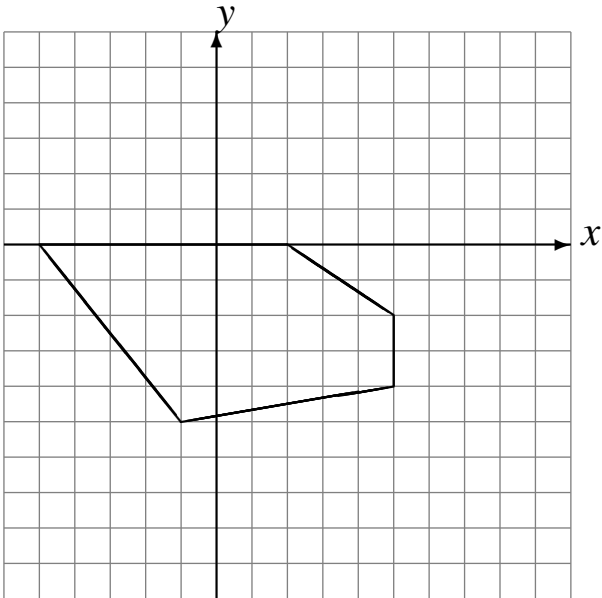

Translate by $(-4, -4)$.

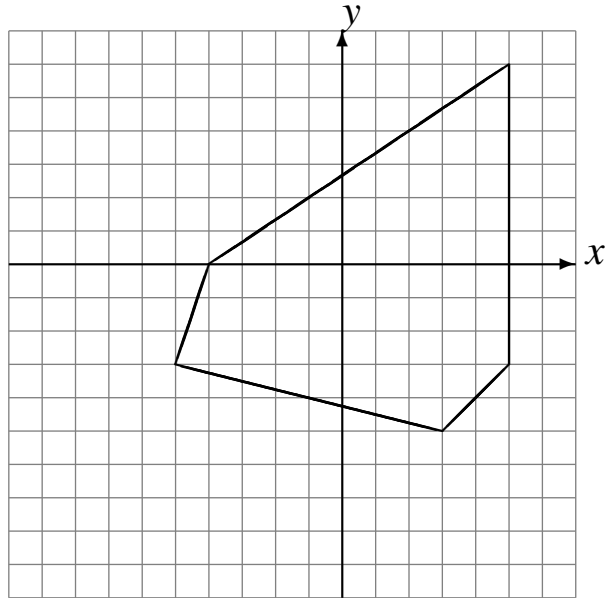

Translations (C) Answers

Draw each translated image.

Translate by $(3, -4)$.

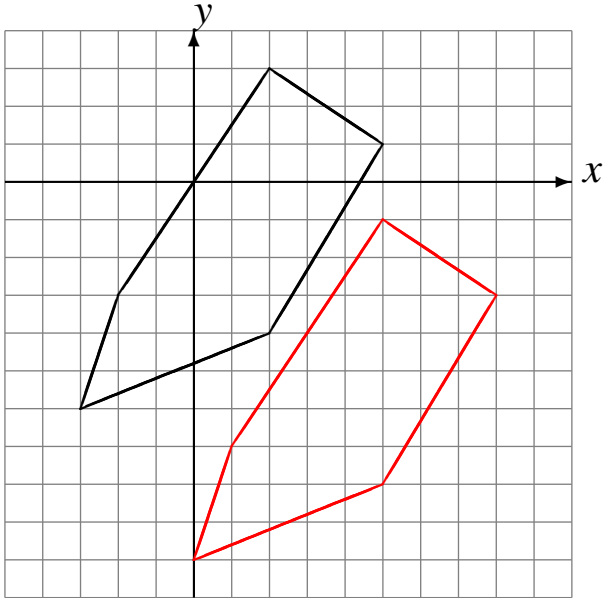

Translate by $(-1, 1)$.

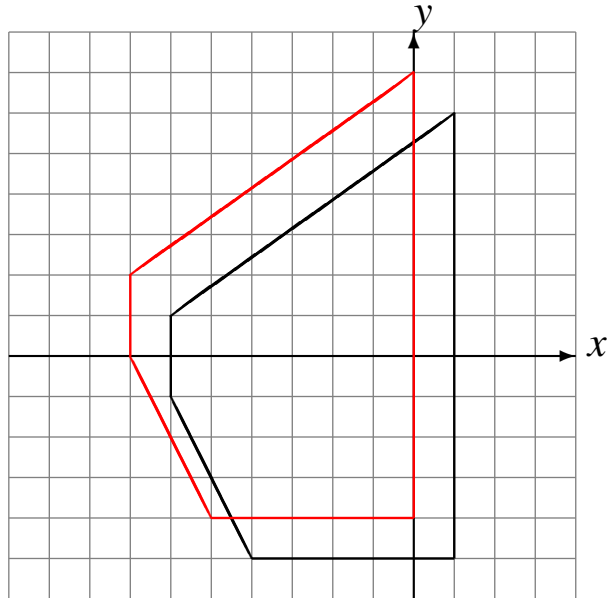

Translate by $(4, 1)$.

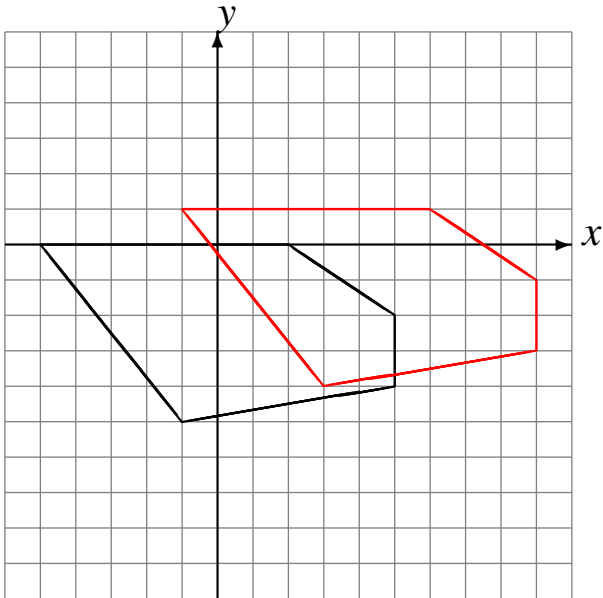

Translate by $(-4, -4)$.

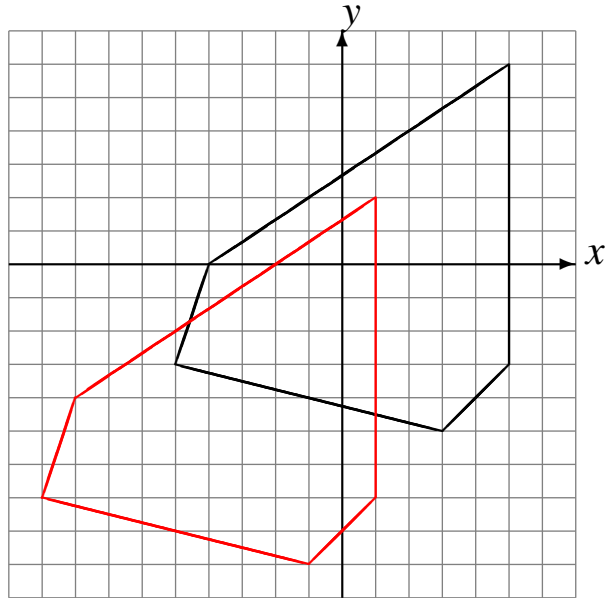

Translations (D)

Draw each translated image.

Translate by $(-1, -3)$.

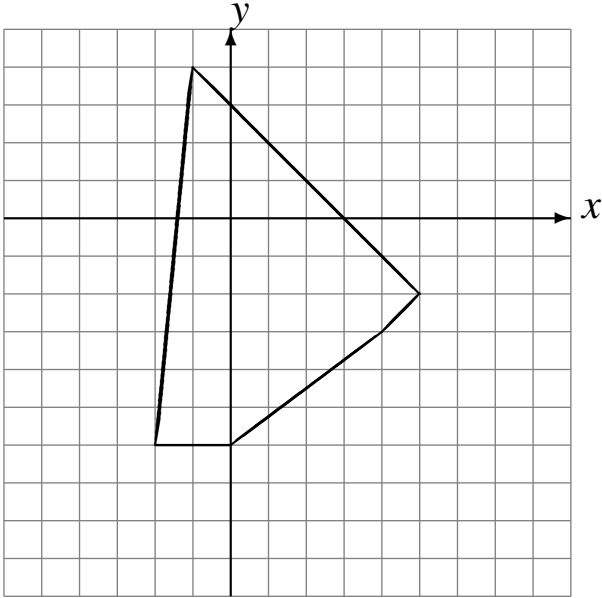

Translate by $(-5, -6)$.

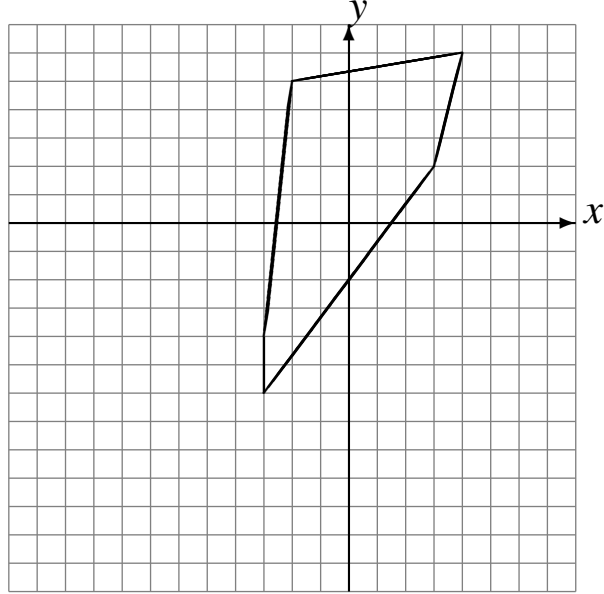

Translate by $(0, -6)$.

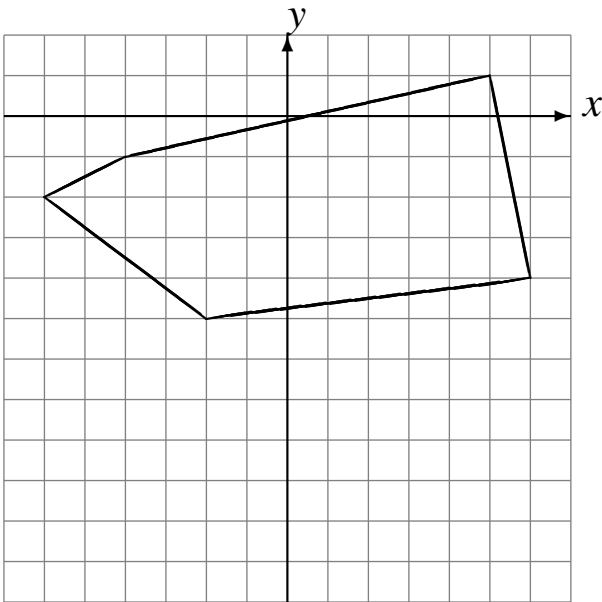

Translate by $(-5, -4)$.

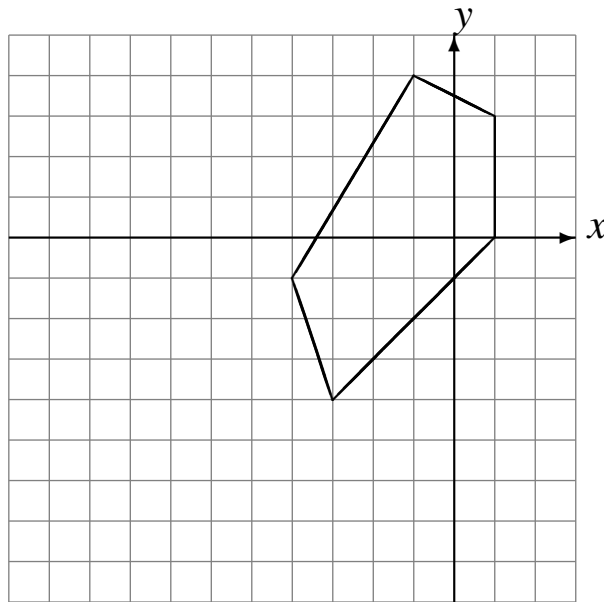

Translations (D) Answers

Draw each translated image.

Translate by $(-1, -3)$.

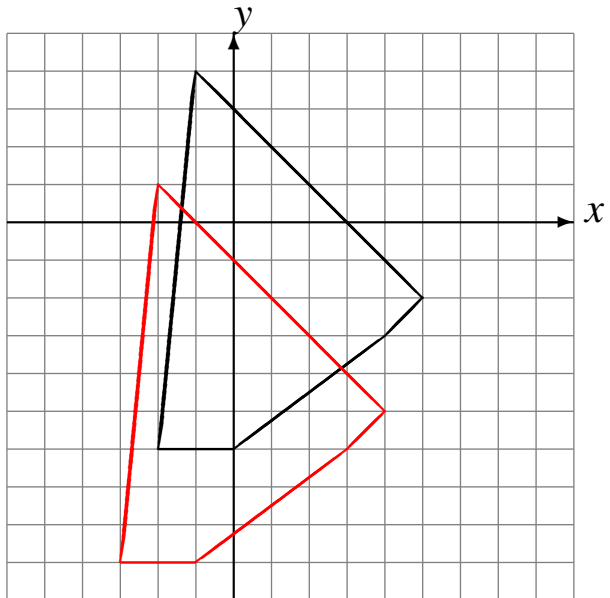

Translate by $(-5, -6)$.

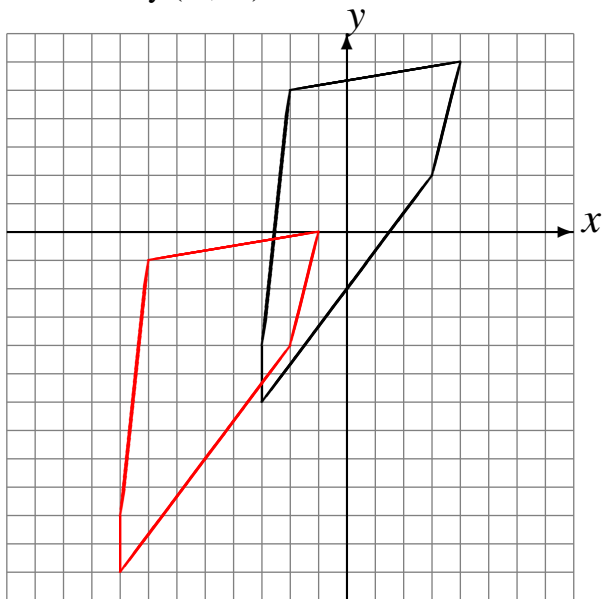

Translate by $(0, -6)$.

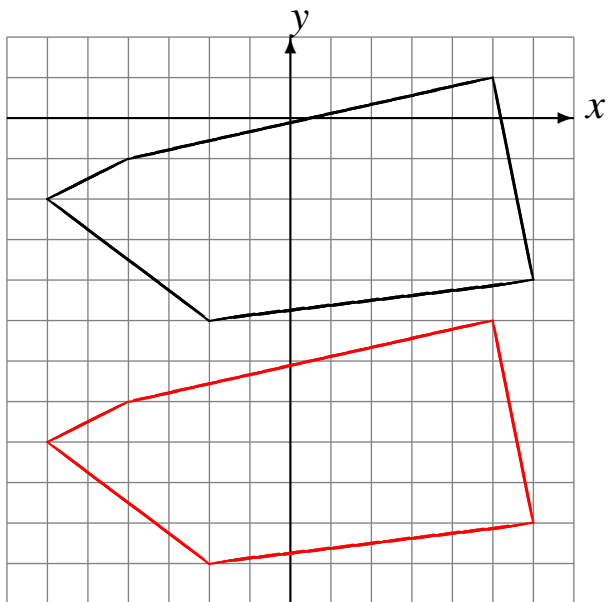

Translate by $(-5, -4)$.

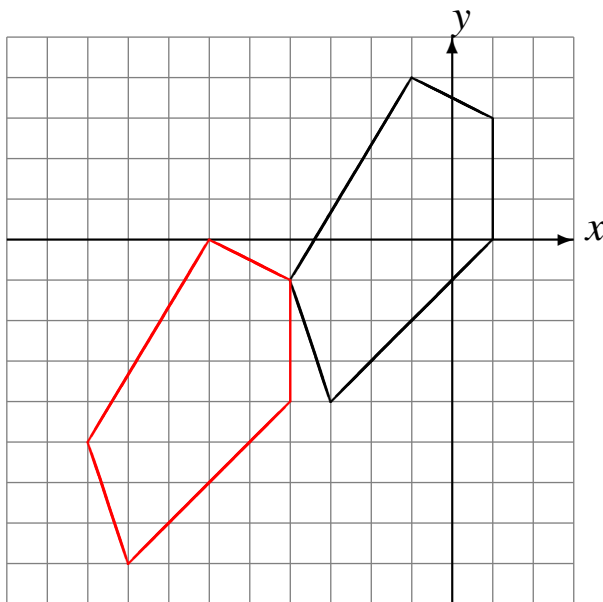

Translations (E)

Draw each translated image.

Translate by $(5, -6)$.

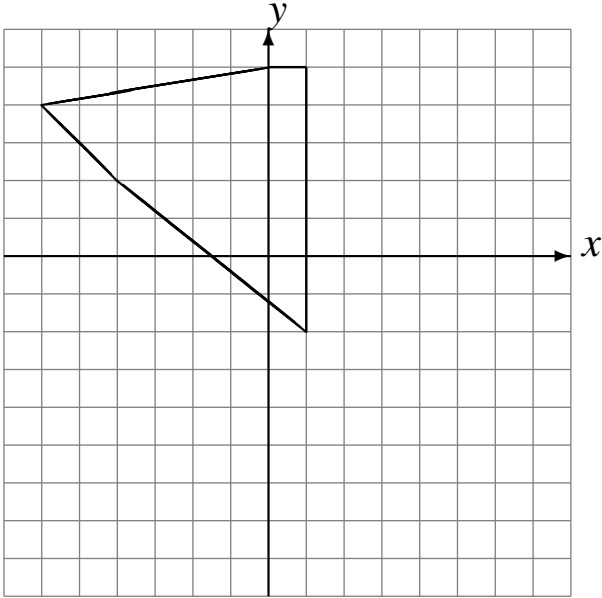

Translate by $(-1, -3)$.

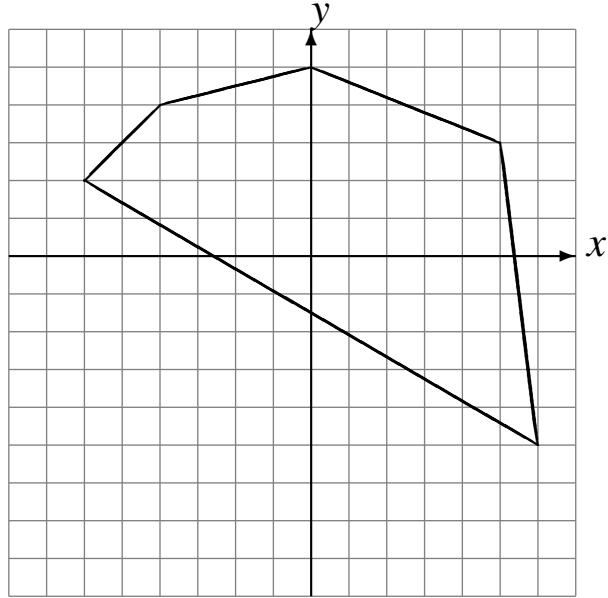

Translate by $(-2, -3)$.

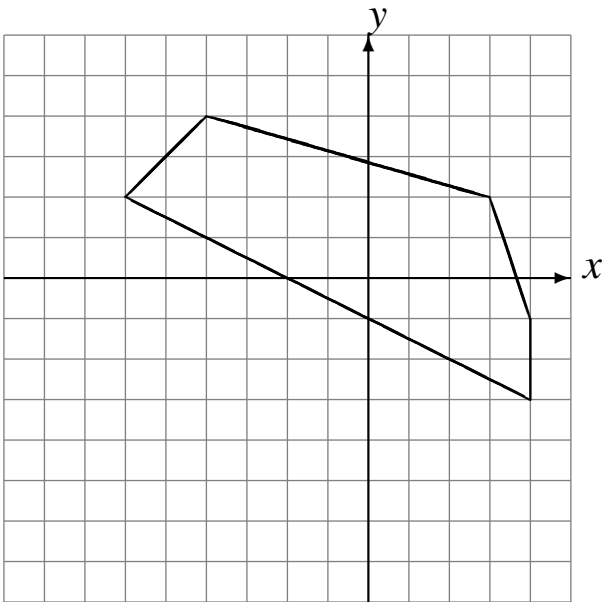

Translate by $(6, 6)$.

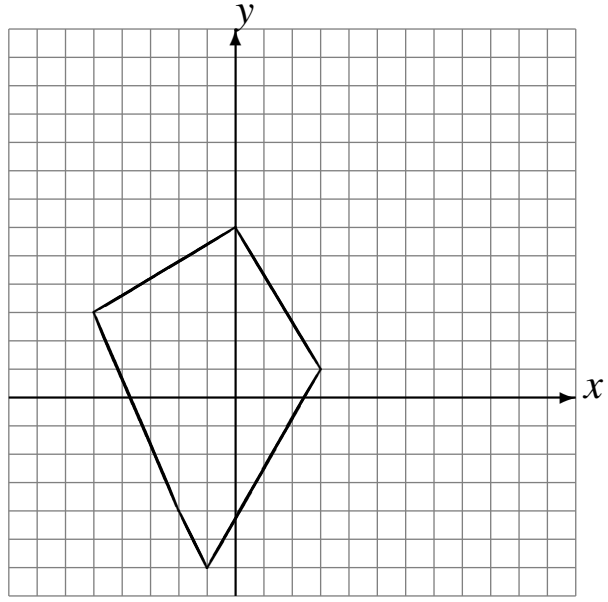

Translations (E) Answers

Draw each translated image.

Translate by $(5, -6)$.

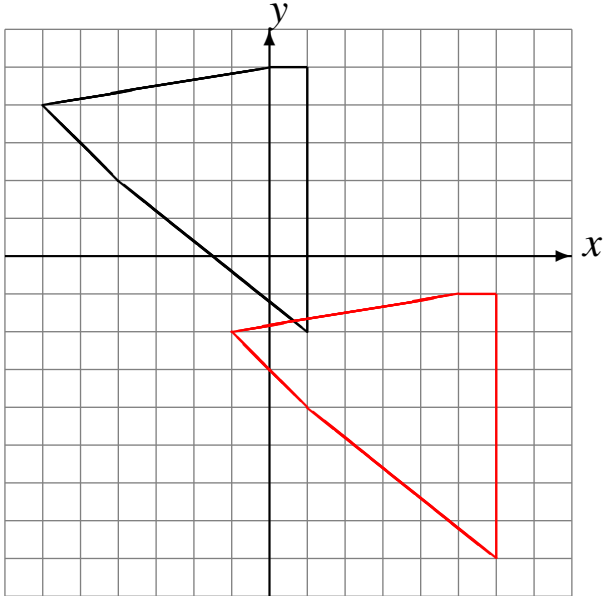

Translate by $(-1, -3)$.

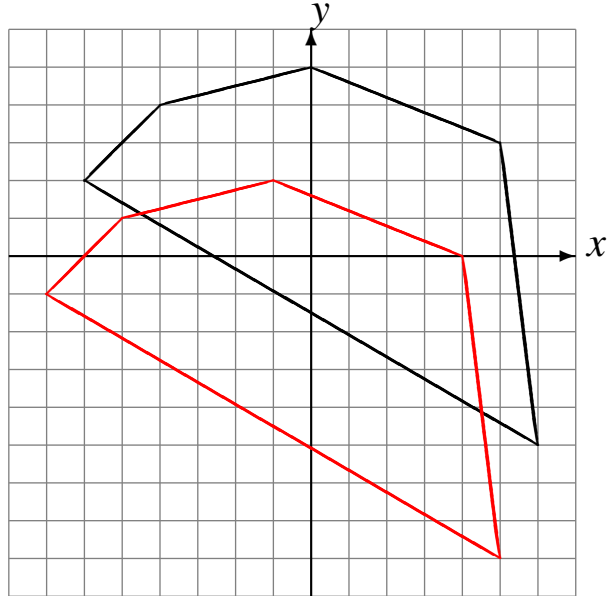

Translate by $(-2, -3)$.

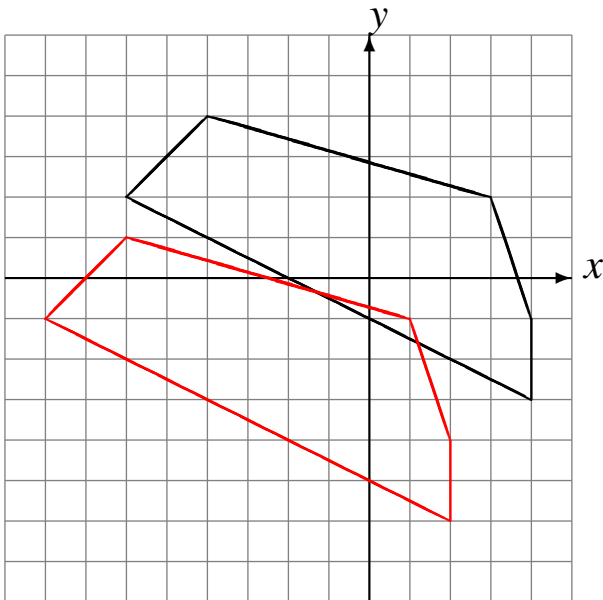

Translate by $(6, 6)$.

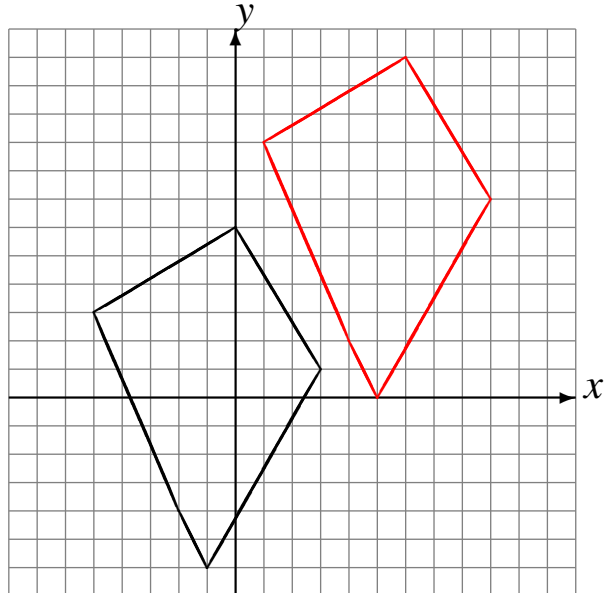

Translations (F)

Draw each translated image.

Translate by $(-2, 2)$.

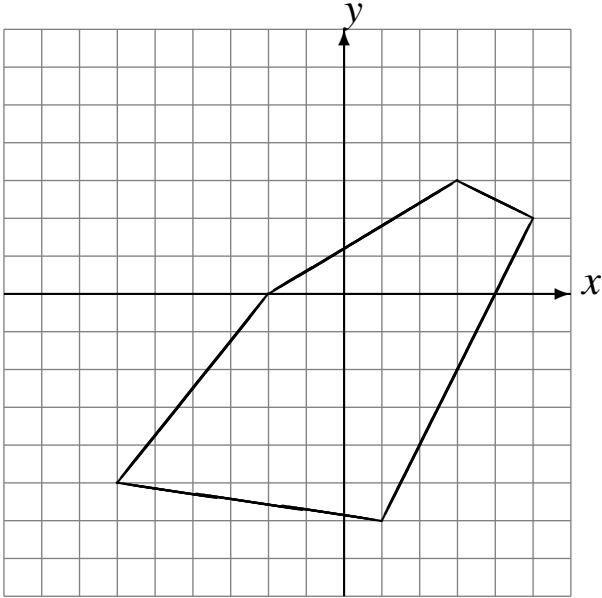

Translate by $(-5, 5)$.

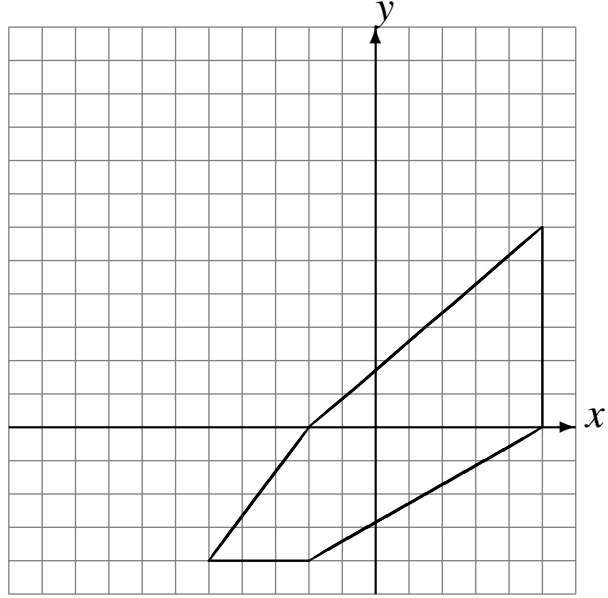

Translate by $(-4, -3)$.

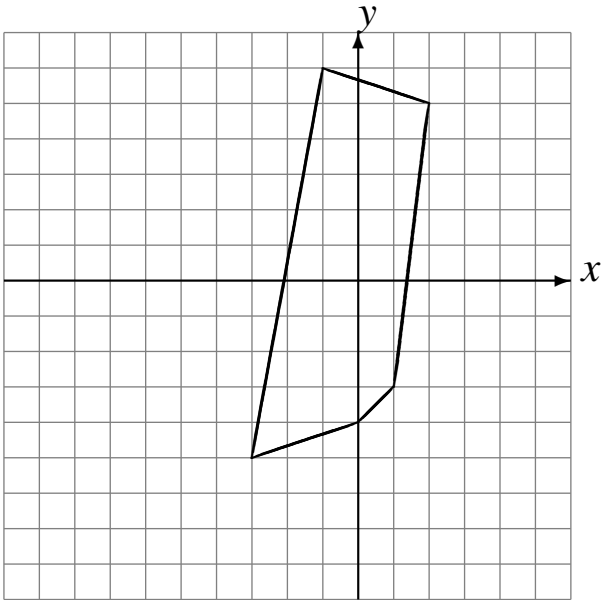

Translate by $(3, 4)$.

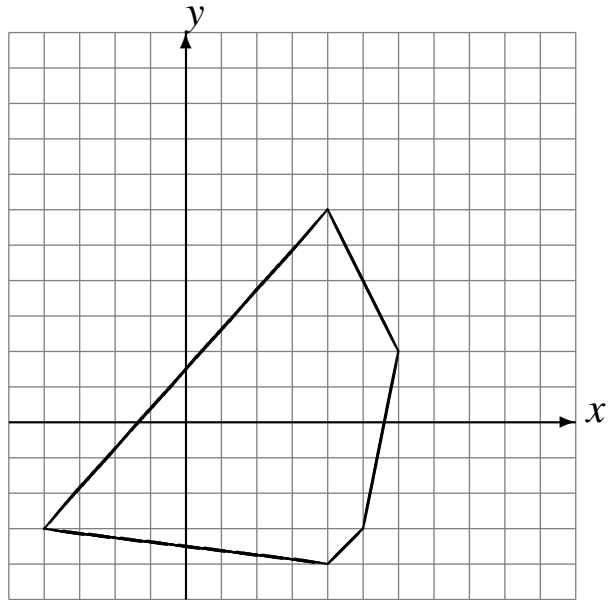

Translations (F) Answers

Draw each translated image.

Translate by $(-2, 2)$.

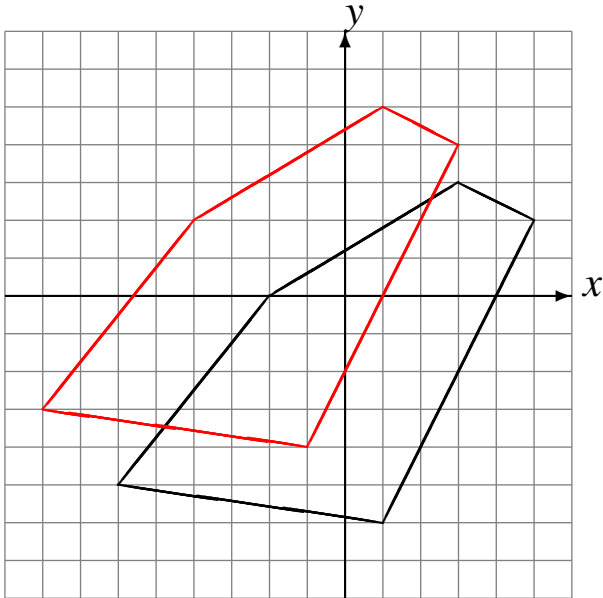

Translate by $(-5, 5)$.

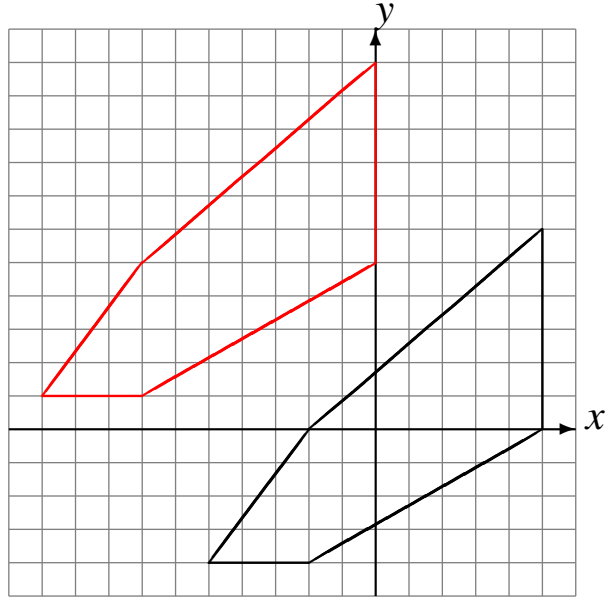

Translate by $(-4, -3)$.

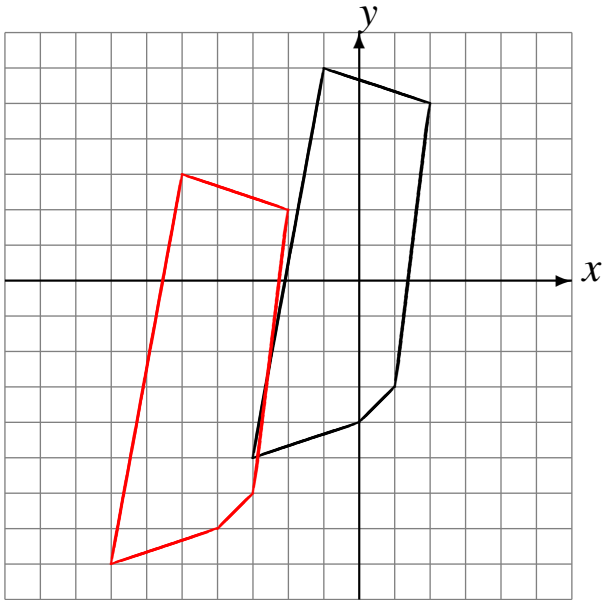

Translate by $(3, 4)$.

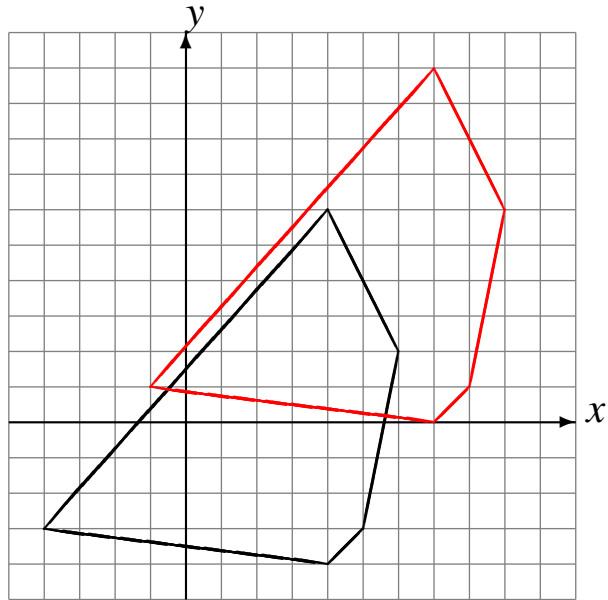

Translations (G)

Draw each translated image.

Translate by $(5, -4)$.

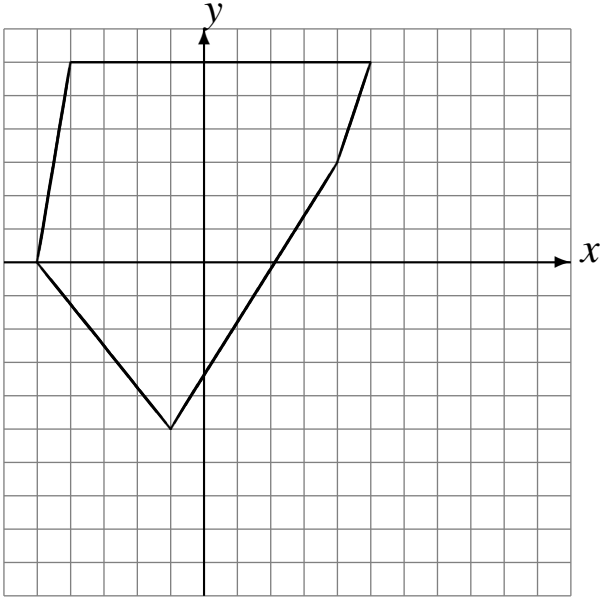

Translate by $(-6, -1)$.

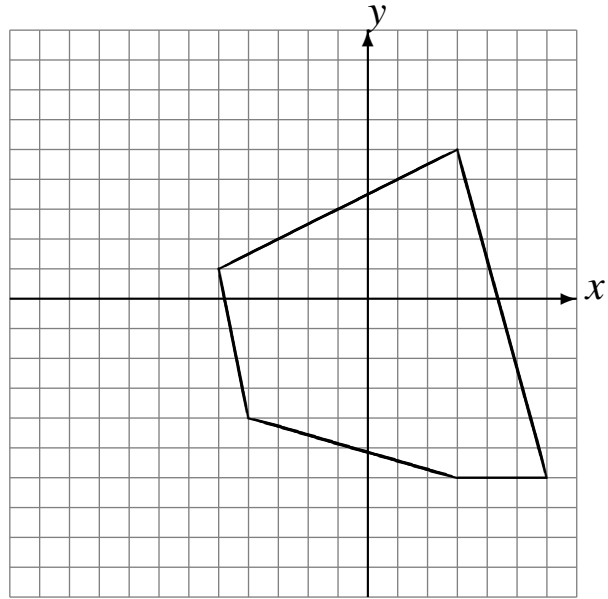

Translate by $(6, -5)$.

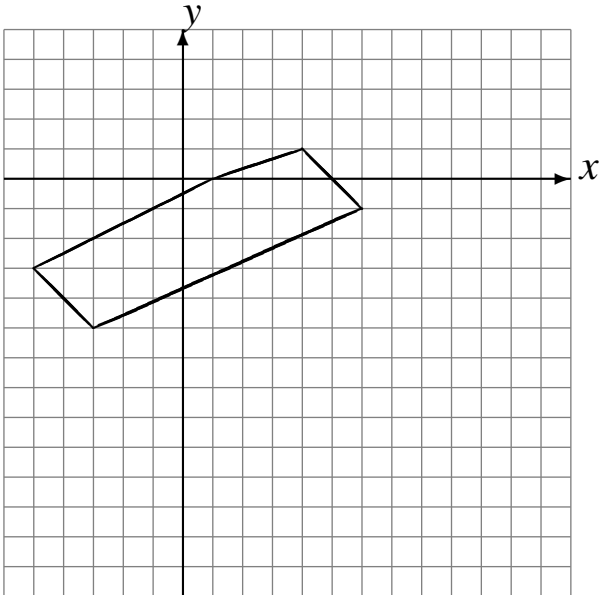

Translate by $(-3, -6)$.

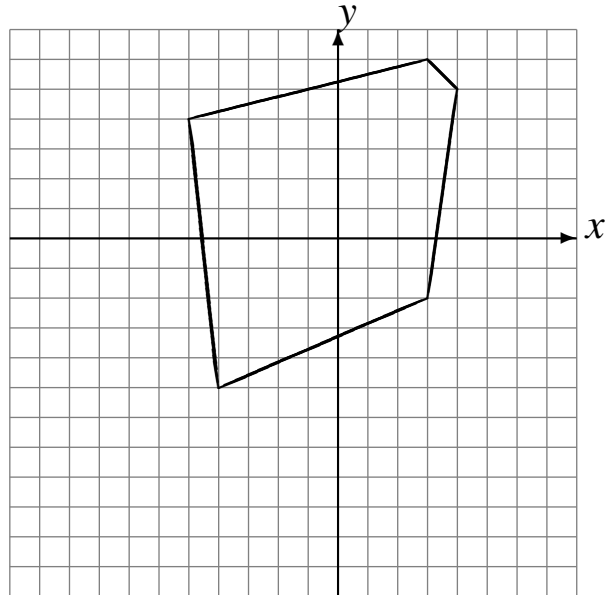

Translations (G) Answers

Draw each translated image.

Translate by $(5, -4)$.

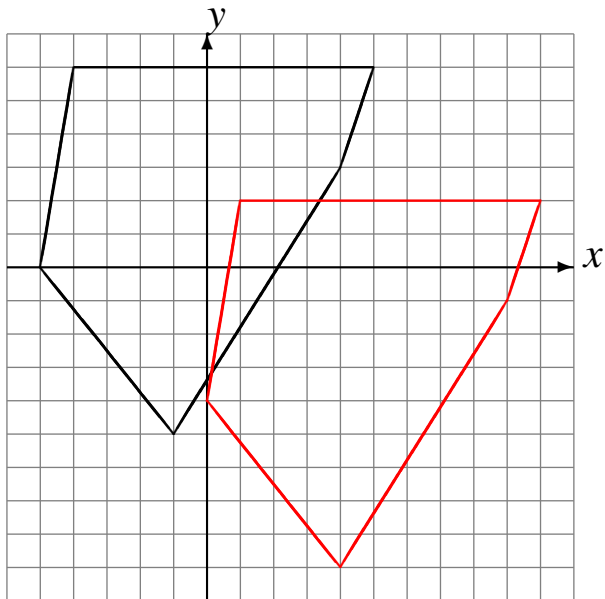

Translate by $(-6, -1)$.

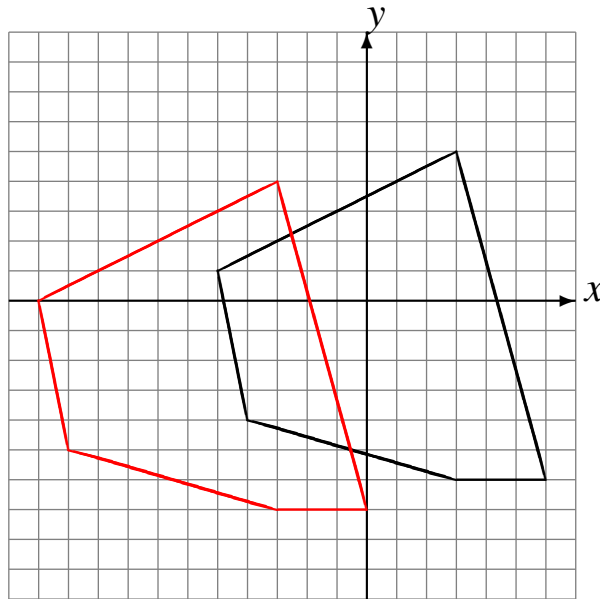

Translate by $(6, -5)$.

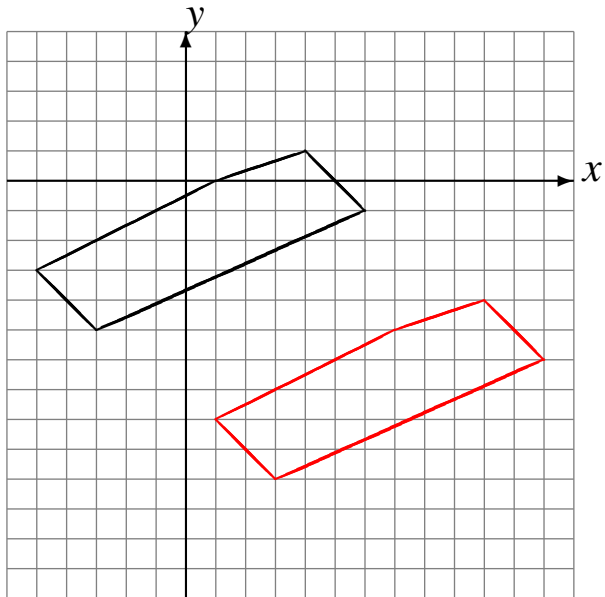

Translate by $(-3, -6)$.

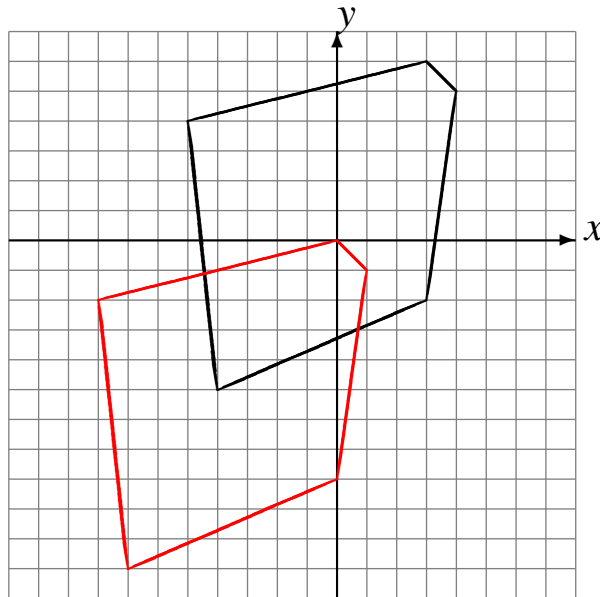

Translations (H)

Draw each translated image.

Translate by $(-4, -5)$.

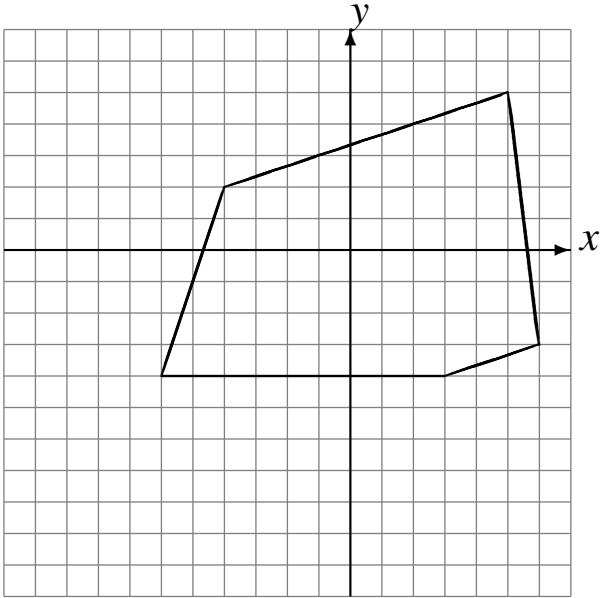

Translate by $(1, 4)$.

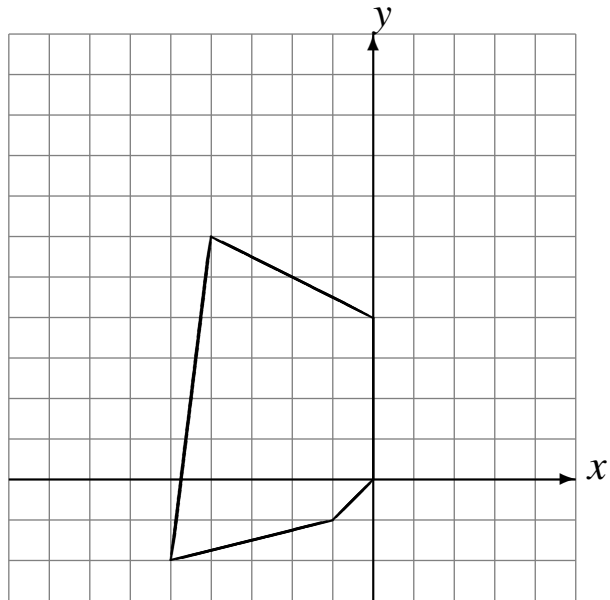

Translate by $(-5, 0)$.

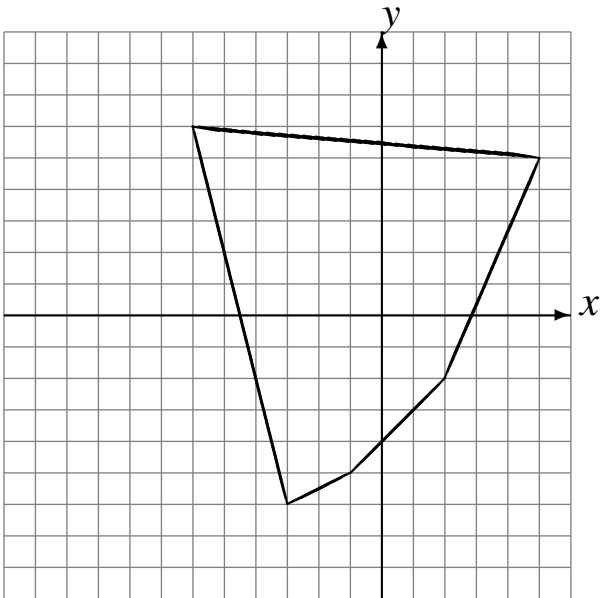

Translate by $(3, -3)$.

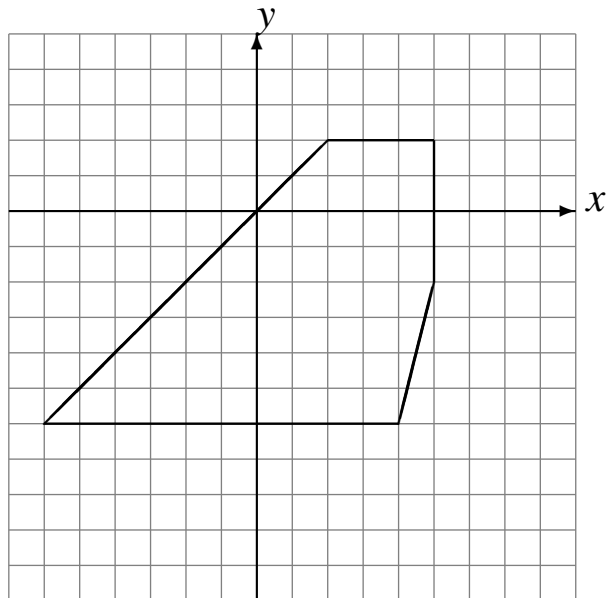

Translations (H) Answers

Draw each translated image.

Translate by $(-4, -5)$.

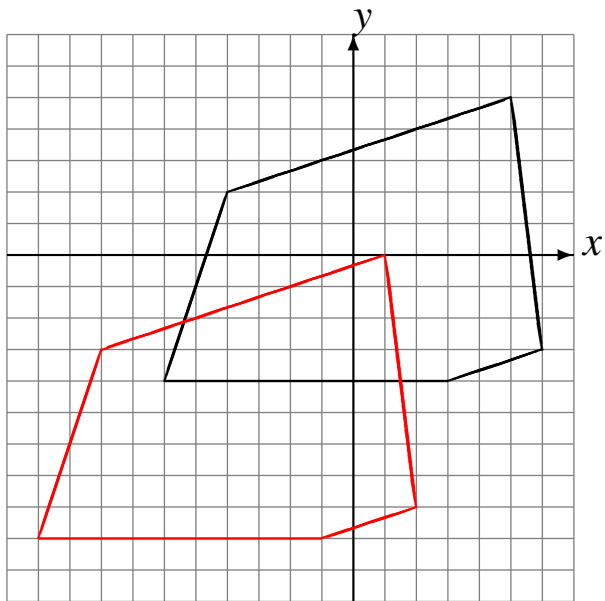

Translate by $(1, 4)$.

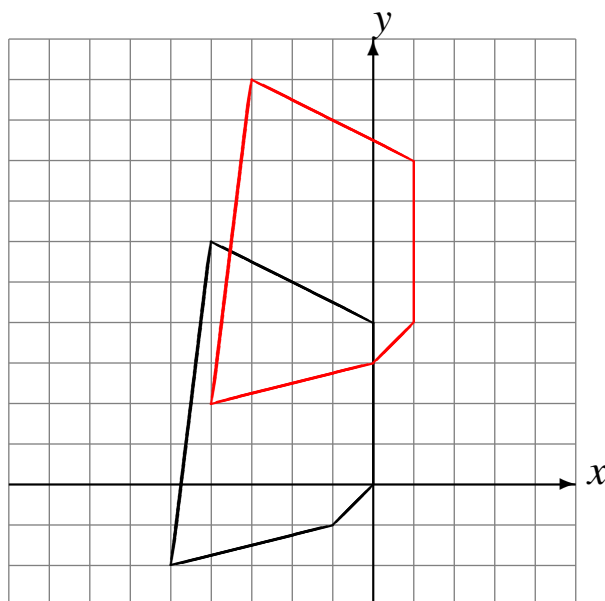

Translate by $(-5, 0)$.

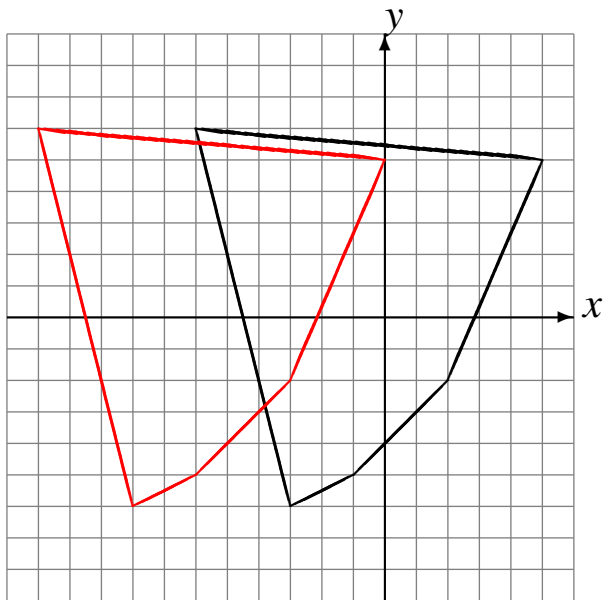

Translate by $(3, -3)$.

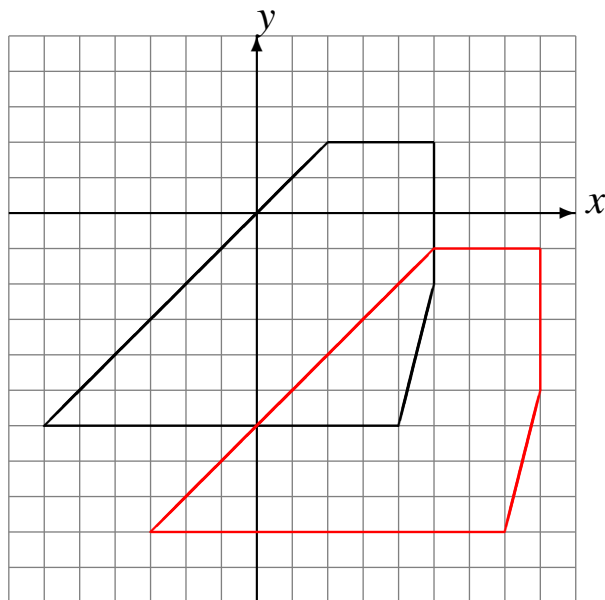

Translations (I)

Draw each translated image.

Translate by $(-3, 1)$.

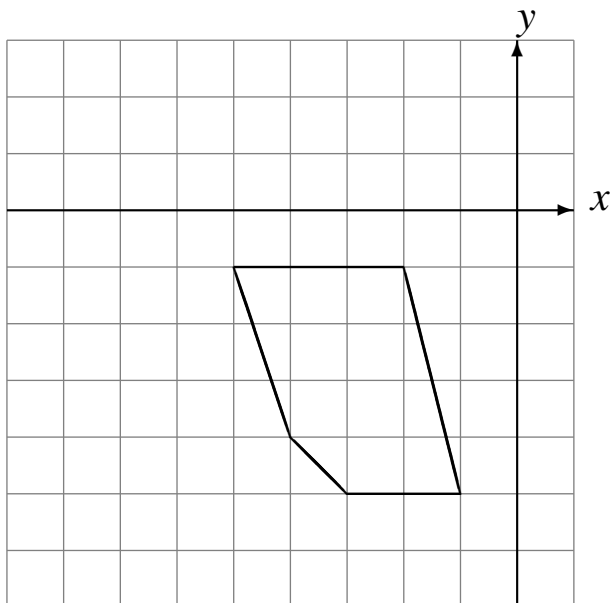

Translate by $(3, -2)$.

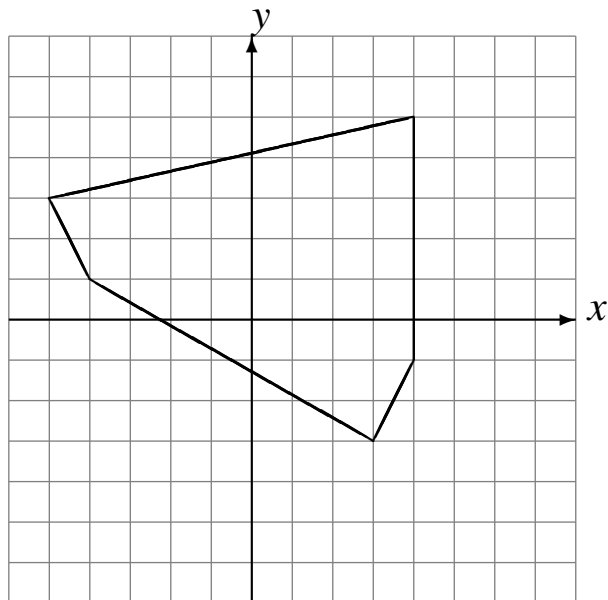

Translate by $(1, 6)$.

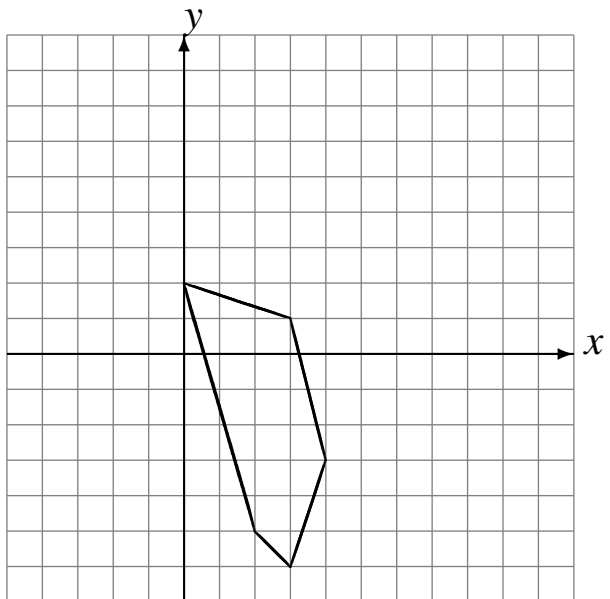

Translate by $(4, -1)$.

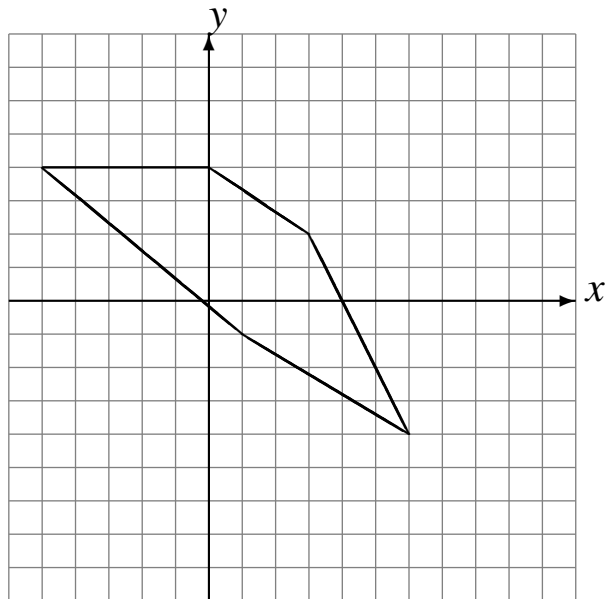

Translations (I) Answers

Draw each translated image.

Translate by $(-3, 1)$.

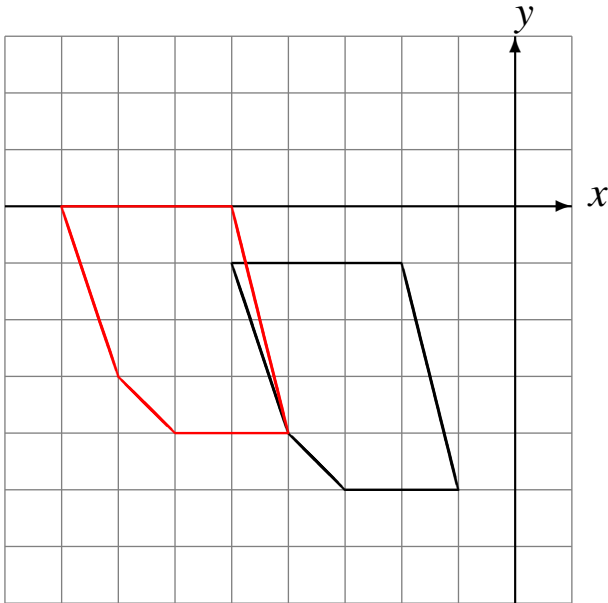

Translate by $(3, -2)$.

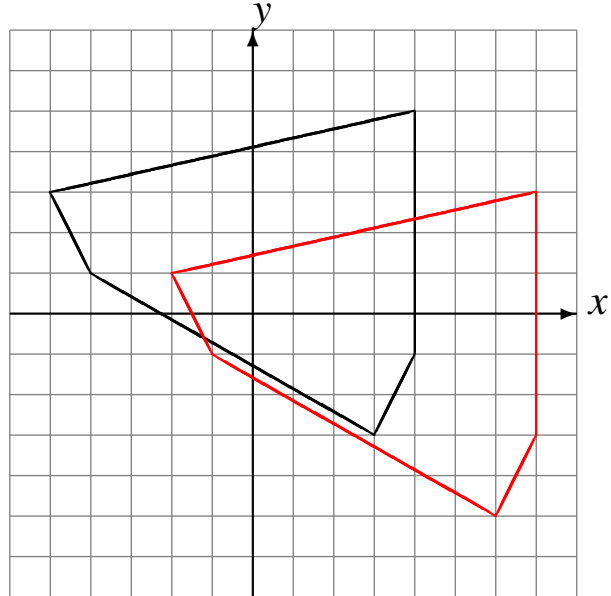

Translate by $(1, 6)$.

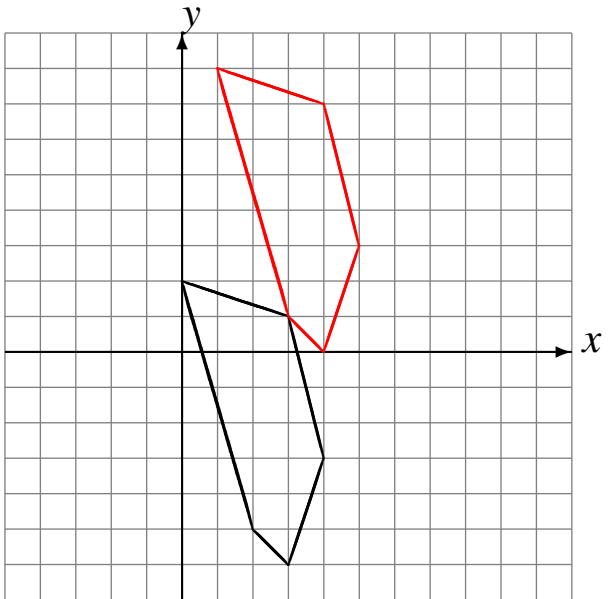

Translate by $(4, -1)$.

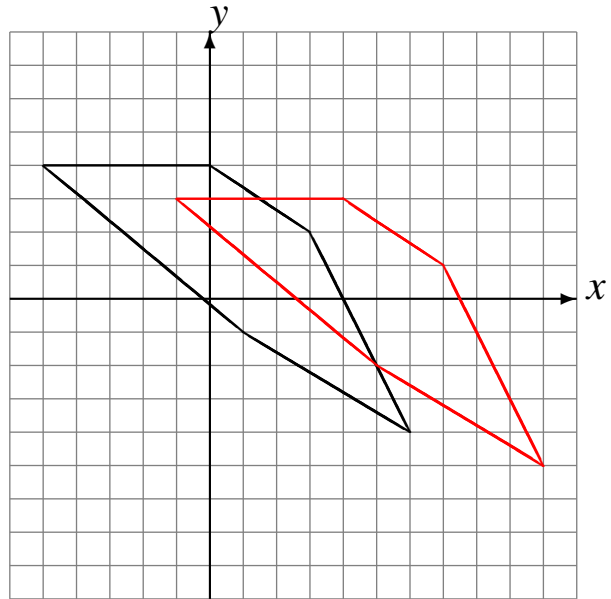

Translations (J)

Draw each translated image.

Translate by $(-1, -1)$.

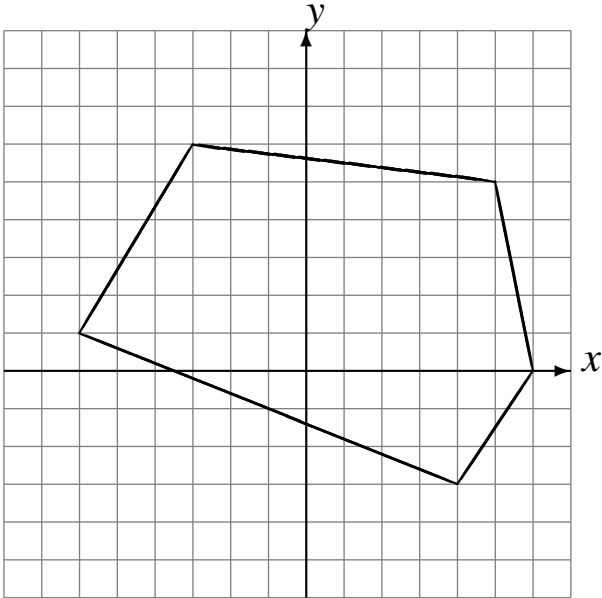

Translate by $(0, 1)$.

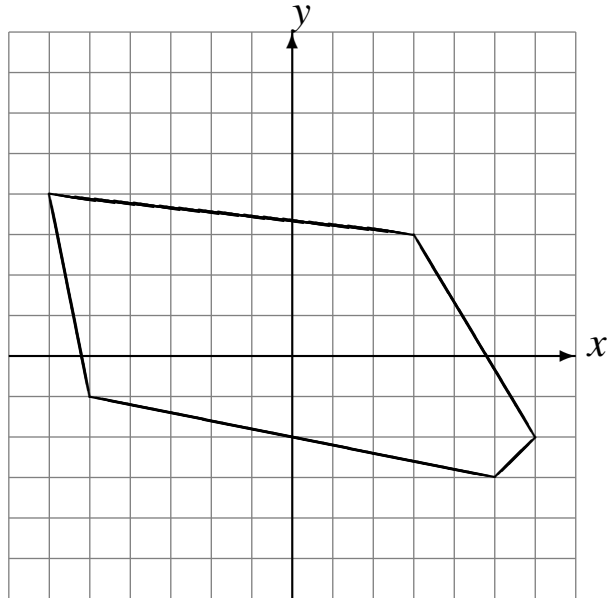

Translate by $(-4, 3)$.

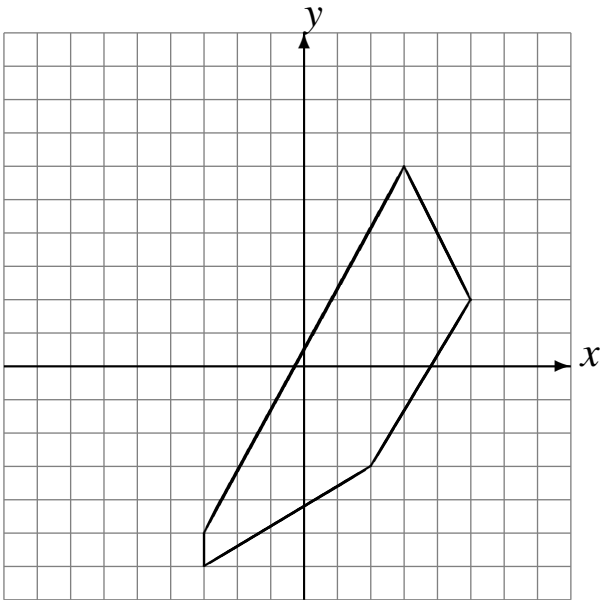

Translate by $(4, 0)$.

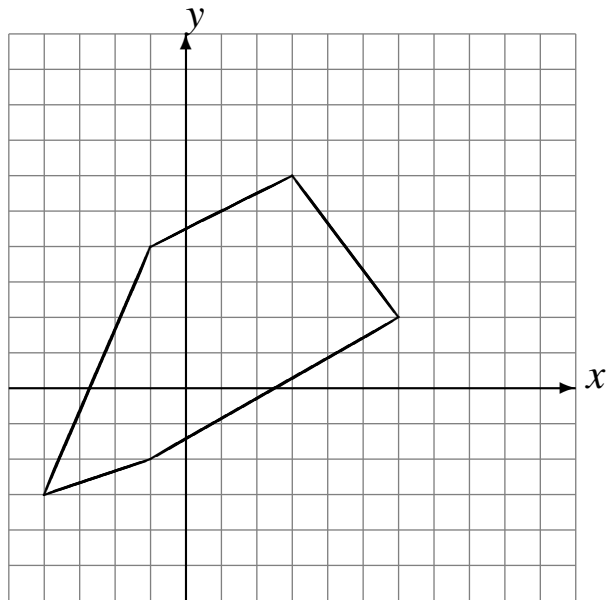

Translations (J) Answers

Draw each translated image.

Translate by $(-1, -1)$.

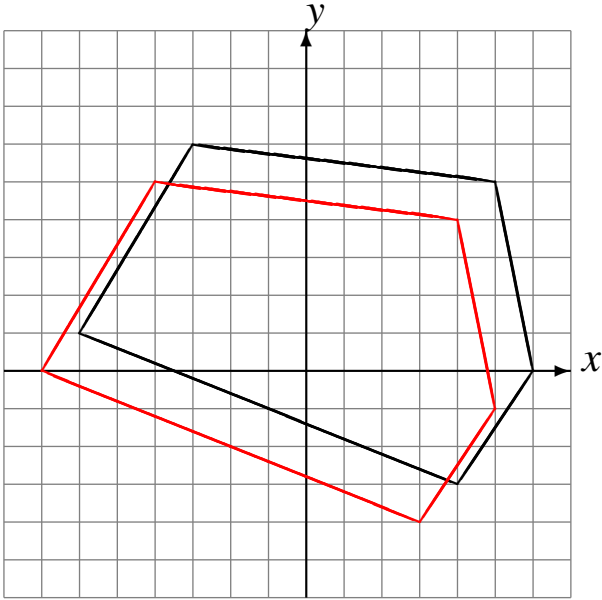

Translate by $(0, 1)$.

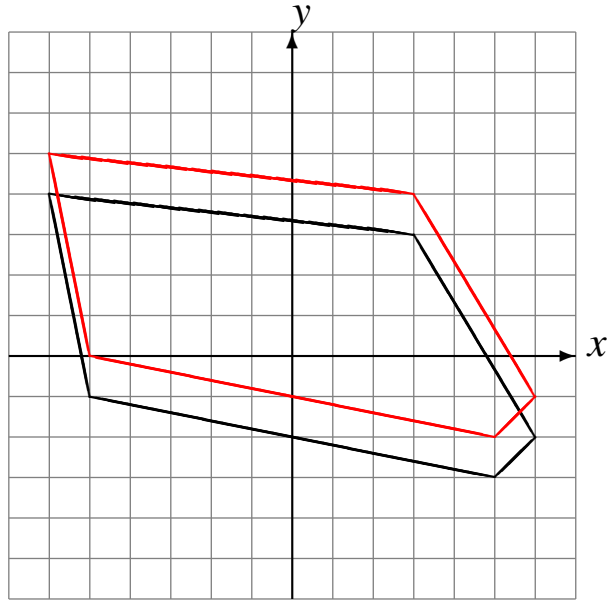

Translate by $(-4, 3)$.

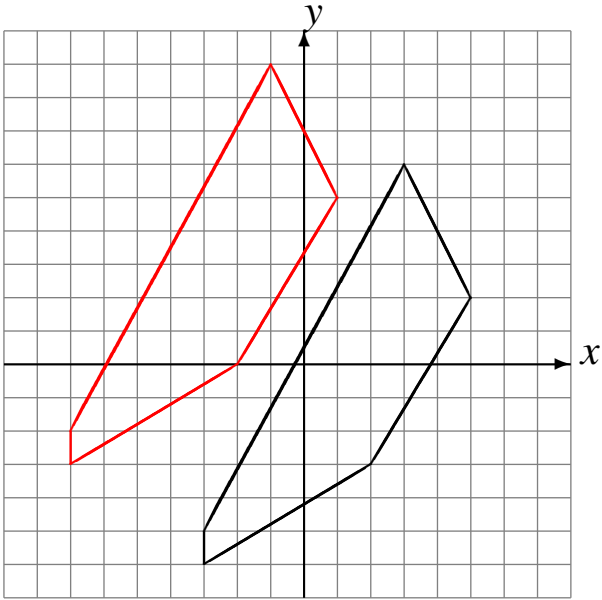

Translate by $(4, 0)$.

